

Home Theater System

Operating Instructions

Owner's Record

The model and serial numbers are located at the rear of the unit. Record the serial number in the space provided below. Refer to them whenever you call upon your Sony dealer regarding this product.

Model No. _____

Serial No. _____

HT-DDW650

WARNING

To prevent fire or shock hazard, do not expose the unit to rain or moisture.

To prevent fire, do not cover the ventilation of the apparatus with newspapers, table-cloths, curtains, etc. And don't place lighted candles on the apparatus.

To prevent fire or shock hazard, do not place objects filled with liquids, such as vases, on the apparatus.



Don't throw away the battery with general house waste, dispose of it correctly as chemical waste.

Do not install the appliance in a confined space, such as a bookcase or built-in cabinet.

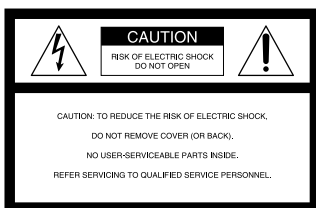

This symbol is intended to alert the user to the presence of uninsulated "dangerous voltage" within the product's enclosure that may be of sufficient magnitude to constitute a risk of electric shock to persons.



This symbol is intended to alert the user to the presence of important operating and maintenance (servicing) instructions in the literature accompanying the appliance.

WARNING

This equipment has been tested and found to comply with the limits for a Class B digital device, pursuant to Part 15 of the FCC Rules. These limits are designed to provide reasonable protection against harmful interference in a residential installation. This equipment generates, uses, and can radiate radio frequency energy and, if not installed and used in accordance with the instructions, may cause harmful interference to radio communications. However, there is no guarantee that interference will not occur in a particular installation. If this equipment does cause harmful interference to radio or television reception, which can be determined by turning the equipment off and on, the user is encouraged to try to correct the interference by one or more of the following measures:

- Reorient or relocate the receiving antenna.
- Increase the separation between the equipment and receiver.
- Connect the equipment into an outlet on a circuit different from that to which the receiver is connected.
- Consult the dealer or an experienced radio/TV technician for help.

CAUTION

You are cautioned that any changes or modification not expressly approved in this manual could void your authority to operate this equipment.

Note to CATV system installer:

This reminder is provided to call CATV system installer's attention to Article 820-40 of the NEC that provides guidelines for proper grounding and, in particular, specifies that the cable ground shall be connected to the grounding system of the building, as close to the point of cable entry as practical.



ENERGY STAR® is a U.S. registered mark.

As an ENERGY STAR® partner, Sony Corporation has determined that this product meets the ENERGY STAR® guidelines for energy efficiency.

This receiver incorporates Dolby® Digital and Pro Logic Surround and the DTS** Digital Surround System.

* Manufactured under license from Dolby Laboratories.

"Dolby", "Pro Logic" and the double-D symbol are trademarks of Dolby Laboratories.

** "DTS" and "DTS Digital Surround" are registered trademarks of Digital Theater Systems, Inc.

Table of Contents

List of Button Locations and Reference Pages

Main unit	5
-----------------	---

Hooking Up the Components

Required cords	6
Antenna hookups	7
Audio component hookups	8
DVD Player/Video Cassette Recorder hookups	9
Video component hookups	10
Digital component hookups	11
Other hookups	12

Hooking Up and Setting Up the Speaker System

Speaker system hookups	13
Performing initial setup operations	15
Multi channel surround setup	15
Checking the connections	20

Basic Operations

Selecting the component	21
Changing the display	22

Enjoying Surround Sound

Using only the front speakers (2 Channel Stereo)	23
Enjoying higher fidelity sound	23
Selecting a sound field	24
Understanding the multi channel surround displays	26
Customizing sound fields	27

Receiving Broadcasts

Direct tuning	29
Automatic tuning	30
Preset tuning	30

Other Operations

Naming preset stations and program sources	32
Recording	32
Adjustments using the SET UP menu	33
Changing the command mode of the receiver	34

Operations Using the Remote RM-PP65

Before you use your remote	35
Remote button description	35
Changing the factory setting of an input selector button	38

Additional Information

Precautions	40
Troubleshooting	40
Specifications	43
Tables of settings using the MAIN MENU button	46
Adjustable parameters for each sound field	47

About This Manual

The HT-DDW650 consists of:

- Receiver STR-K650P
- Speaker system
 - Front/surround speakers SS-MSP75
 - Center speaker SS-CNP75
 - Sub woofer SA-WMSP85

Tip

The instructions in this manual describe the controls on the receiver. You can also use the controls on the supplied remote if they have the same or similar names as those on the receiver. For details on the use of your remote, see pages 35 – 39.

Note for the supplied remote

For RM-PP65

The >10/11 and 12 buttons on the remote are not available.

How to use this page

Use this page to find the location of buttons that are mentioned in the text.

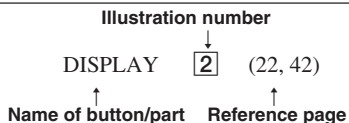

Main unit

ALPHABETICAL ORDER

A - L

- A.F.D. (button/indicator) **20** (23-25)
- CD **9** (21)
- DIMMER **3** (22)
- DISPLAY **2** (22, 42)
- Display **11** (22)
- DVD **7** (21)
- ENTER **15** (32, 34)
- FM MODE **24** (29)
- INPUT MODE **13** (21)
- IR (receptor) **4** (35, 42)

M - O

- MAIN MENU **14** (16, 27, 28, 32, 33, 46)
- MASTER VOLUME **12** (19, 21, 40)
- MD/TAPE **8** (21)
- MEMORY **25** (30)
- MENU +/- **16** (16, 27, 28, 32, 33, 46)
- MENU </> **17** (16, 27, 28, 32, 33, 46)
- MOVIE (button/indicator) **19** (24, 41)
- MUSIC (button/indicator) **18** (24, 25, 41)

P - Z

- PHONES (jack) **26** (21, 26, 41)
- PRESET TUNING +/- **22** (30, 31, 44)
- TUNER FM/AM **10** (21, 30, 31, 32)
- TUNING +/- **23** (29, 30)
- VIDEO 1 **5** (21)
- VIDEO 2 **6** (21)

NUMBERS AND SYMBOLS

- 2CH (button/indicator) **21** (23, 25, 28)
- I/O (power) **1** (15, 20, 28, 34, 44)

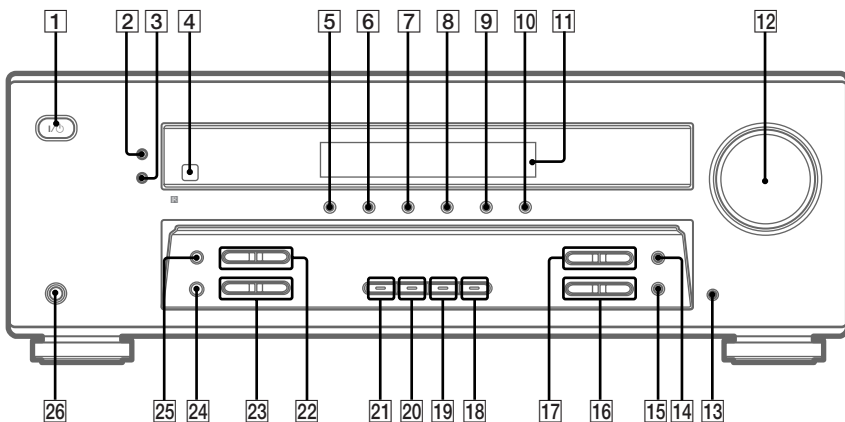

Required cords

The following optional connection cords **A** – **E** are required when you hook up the components (pages 8 – 11).

A Audio cord (supplied (1 only))



B Audio/video cord (not supplied)

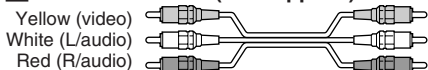

C Video cord (supplied (1 only))

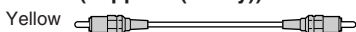

D Optical digital cord (not supplied)

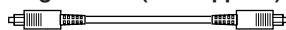

E Coaxial digital cord (supplied)

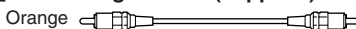

F Component video cord (not supplied)

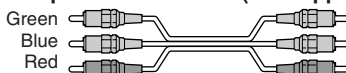

Before you get started

- Turn off the power to all components before making any connections.
- Do not connect the AC power cord until all of the connections are completed.
- Be sure to make connections firmly to avoid hum and noise.
- When connecting an audio/video cord, be sure to match the color-coded pins to the appropriate jacks on the components: yellow (video) to yellow; white (left, audio) to white; and red (right, audio) to red.
- When you connect optical digital cords, insert the cord plugs straight in until they click into place.
- Do not bend or tie the optical digital cord.

Antenna hookups

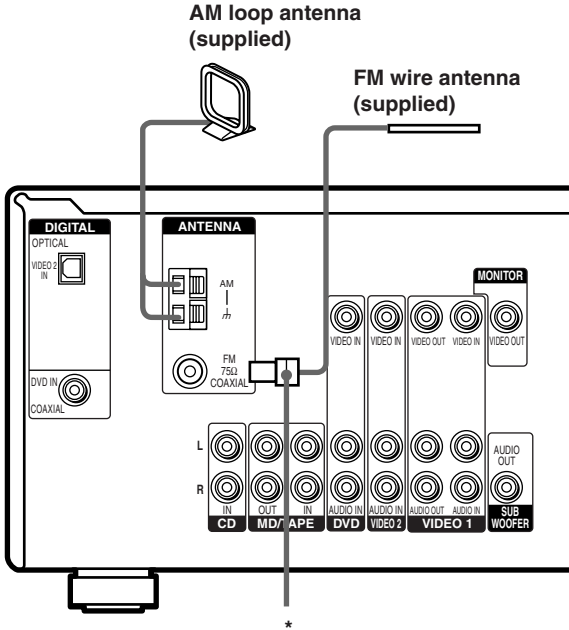

* The shape of the connector varies depending on the area code.

Notes on antenna hookups

- To prevent noise pickup, keep the AM loop antenna away from the receiver and other components.
- Be sure to fully extend the FM wire antenna.
- After connecting the FM wire antenna, keep it as horizontal as possible.

Audio component hookups

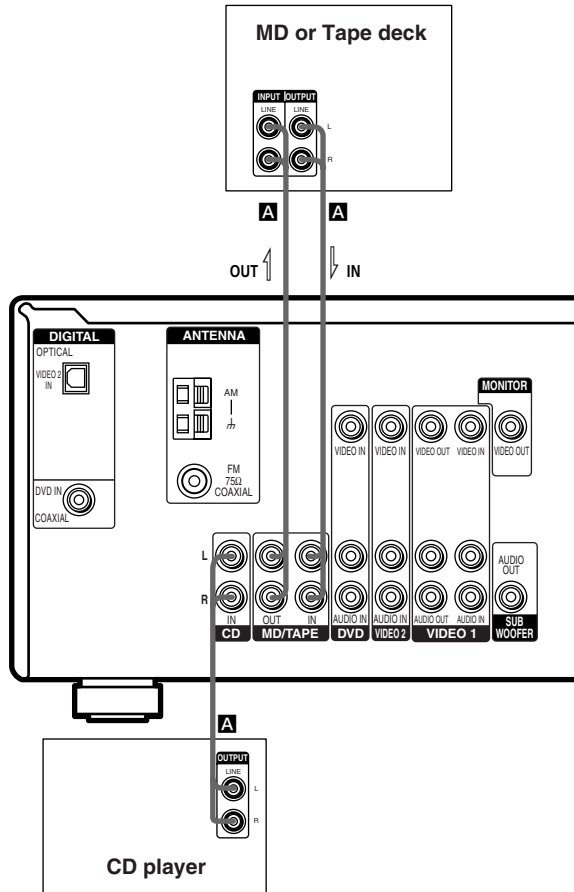

DVD Player/Video Cassette Recorder hookups

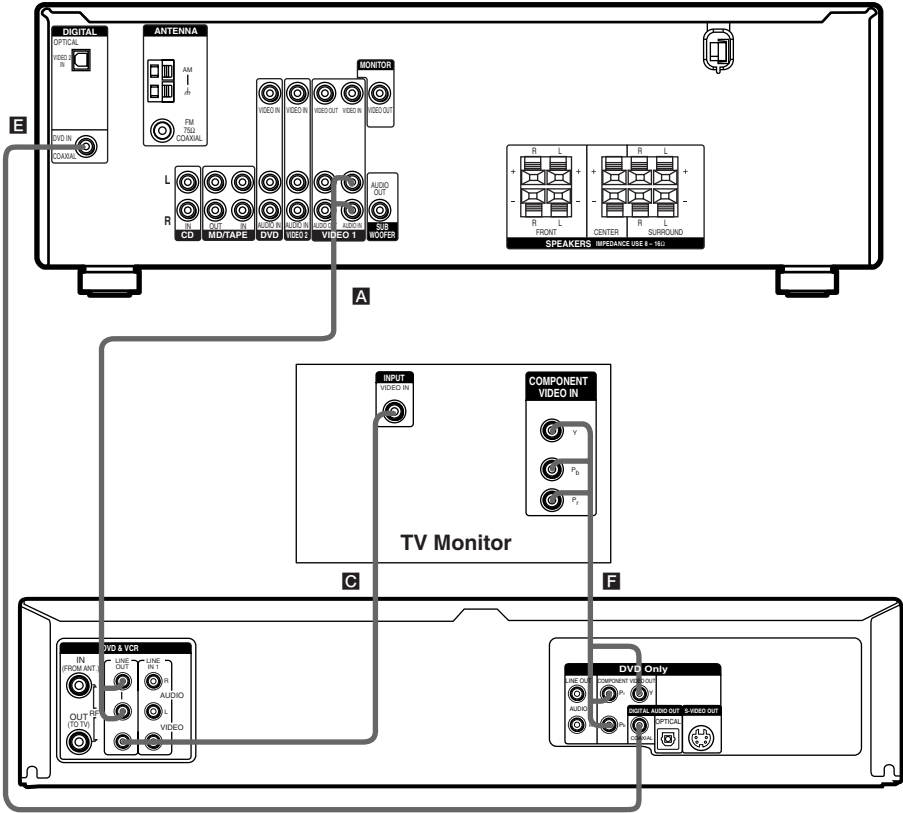

Note

If your TV has COMPONENT VIDEO input jacks, you can use a component video cord (not supplied) to connect the DVD Player/video Cassette Recorder to your TV.

Video component hookups

If you are not going to hookup a DVD Player/Video Cassette Recorder, you can hookup your video components as shown below.

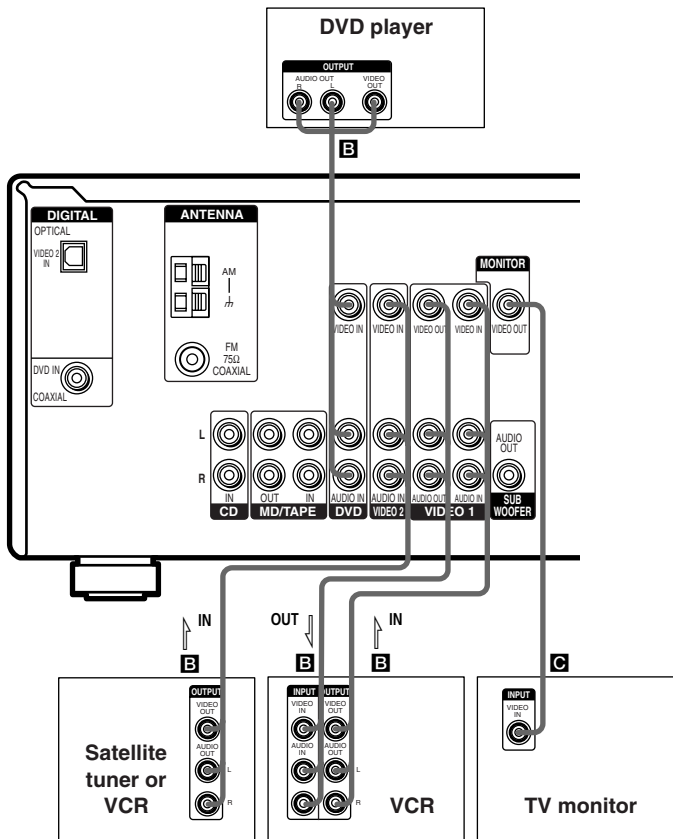

Note on video component hookups

You can connect your TV's audio output jacks to the VIDEO 2 AUDIO IN jacks on the receiver and apply sound effects to the audio from the TV. In this case, do not connect the TV's video output jack to the VIDEO 2 VIDEO IN jack on the receiver. If you are connecting a separate satellite tuner, connect both the audio and video output jacks to the receiver as shown above.

Digital component hookups

If you are not going to hookup a DVD Player/Video Cassette Recorder, you can hookup your digital components as shown below.

Connect the digital output jacks of your DVD player and satellite tuner (etc.) to the receiver's digital input jacks to bring the multi channel surround sound of a movie theater into your home. To fully enjoy multi channel surround sound, five speakers (two front speakers, two surround speakers, and a center speaker) and a sub woofer are required.

Note

All the OPTICAL and COAXIAL jacks are compatible with 96 kHz, 48 kHz, 44.1 kHz and 32 kHz sampling frequencies.

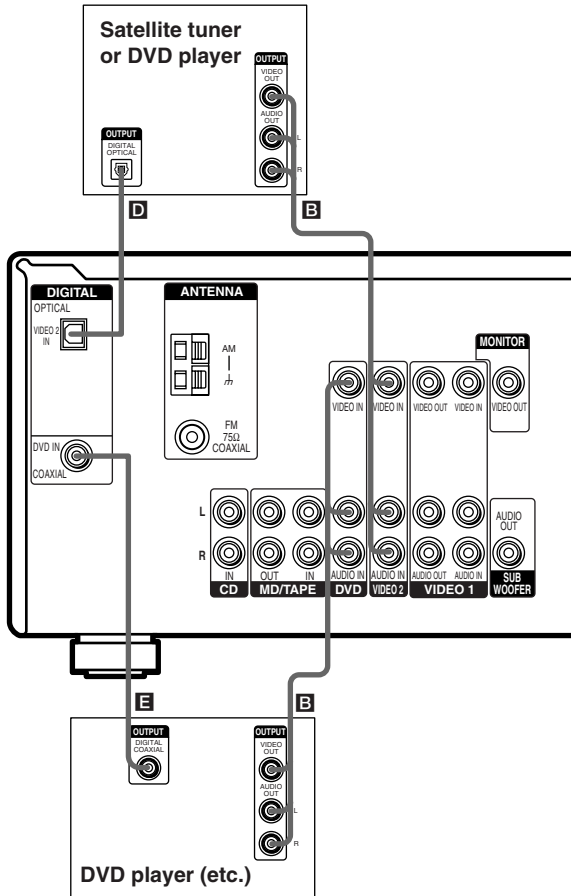

Other hookups

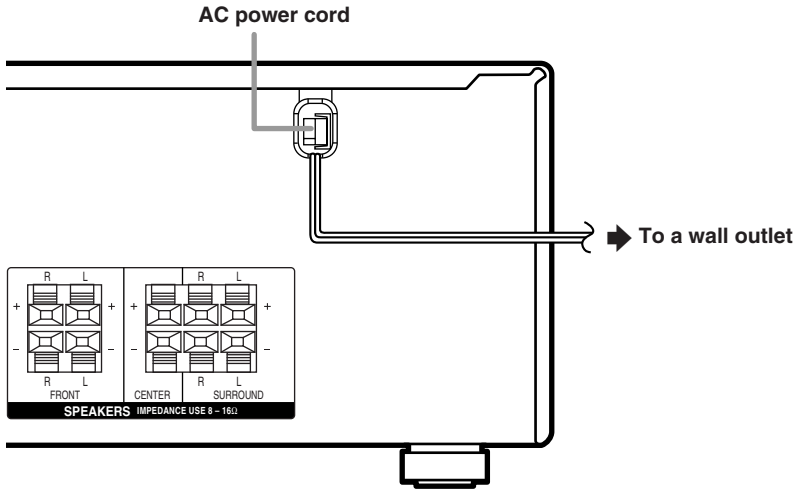

Connecting the AC power cord

Before connecting the AC power cord of this receiver to a wall outlet, connect the speaker system to the receiver (page 13).

Connect the AC power cord(s) of your audio/video components to a wall outlet.

Speaker system hookups

Required cords

A Speaker cords (supplied)



B Monaural audio cord (supplied)

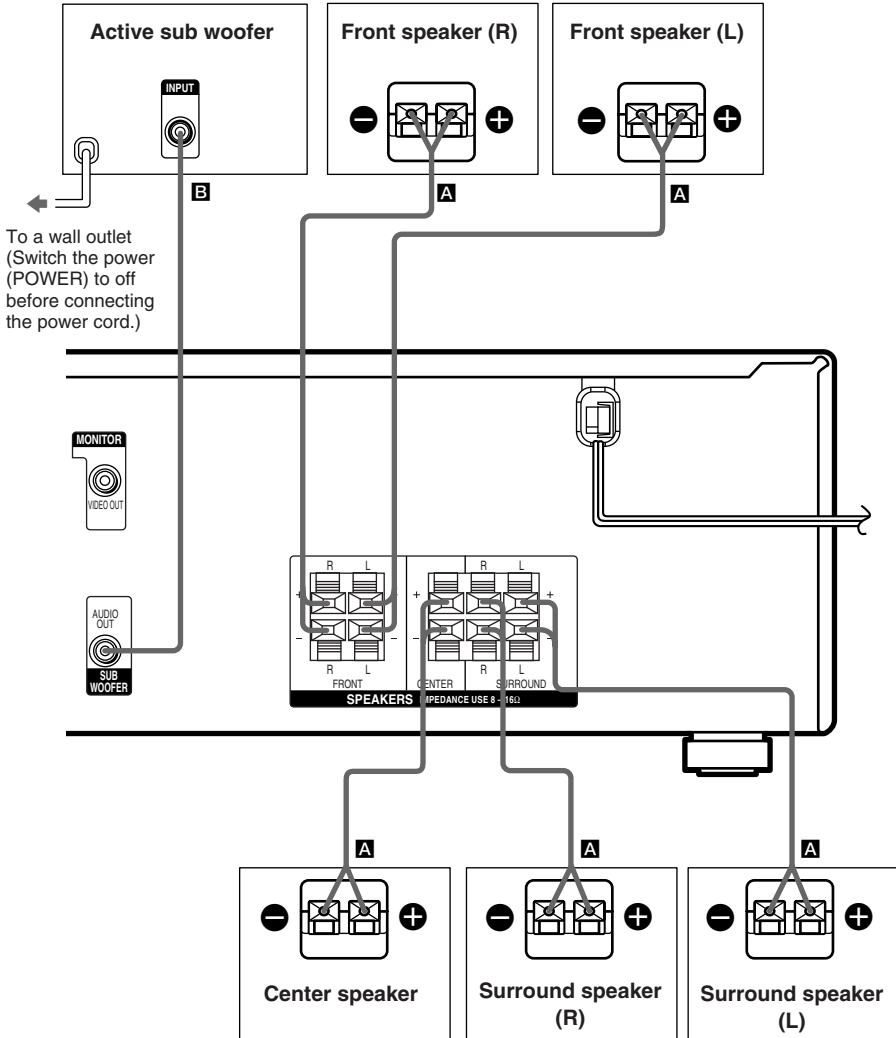
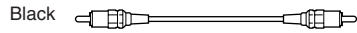

continued

Speaker system hookups (continued)

Tip

To prevent speaker vibration or movement while listening, attach the supplied foot pads at the bottom of the speakers.

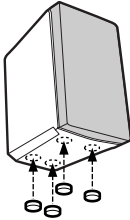

Notes

- Connect the long speaker connecting cords to the surround speaker terminals and the short speaker connecting cords to the front and center speaker terminals.
- Twist the stripped ends of the speaker cords about 2/3 inch. Be sure to match the speaker cord to the appropriate terminal on the components: + to + and - to -. If the cords are reversed, the sound will be distorted and will lack bass.
- If you use speakers with low maximum input rating, adjust the volume carefully to avoid excessive output on the speakers.

To avoid short-circuiting the speakers

Short-circuiting of the speakers may damage the receiver. To prevent this, make sure to take the following precautions when connecting the speakers.

Make sure the stripped ends of each speaker cord does not touch another speaker terminal, the stripped end of another speaker cord, or the metal parts of the receiver.

Examples of poor conditions of the speaker cord

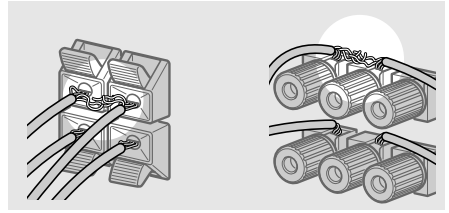

Stripped speaker cord is touching another speaker terminal.

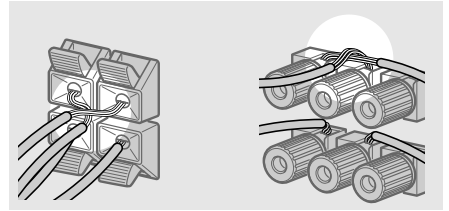

Stripped cords are touching each other due to excessive removal of insulation.

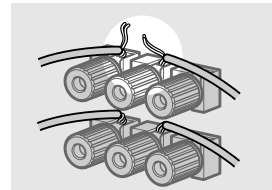

Stripped cords are not fully attached and are touching the rear panel of the receiver.

After connecting all the components, speakers, and AC power cord, output a test tone to check that all the speakers are connected correctly. For details on outputting a test tone, see page 19.

If no sound is heard from a speaker while outputting a test tone or a test tone is output from a speaker other than the one whose name is currently displayed on the receiver, the speaker may be short-circuited. If this happens, check the speaker connection again.

To avoid damaging your speakers

Make sure that you turn down the volume before you turn off the receiver. When you turn on the receiver, the volume remains at the level you turn off the receiver.

Performing initial setup operations

Once you have hooked up the speakers and turned on the power, clear the receiver's memory. Then specify the speaker parameters (size, position, etc.) and perform any other initial setup operations necessary for your system.

Tip

To check the audio output during settings (to set up while outputting the sound), check the connection (page 20).

Clearing the receiver's memory

Before using your receiver for the first time, or when you want to clear the receiver's memory, do the following.

1 Turn off the receiver.

2 Hold down I/⏻ for 5 seconds.

“INITIAL” appears in the display.

The following are reset to their factory settings.

- All settings in the SET UP, LEVEL and TONE menus.
- The sound field memorized for each input selector and preset station.
- All sound field parameters.
- All preset stations.
- All index names of input selectors and preset stations.
- The master volume is set to “VOL MIN”.

Performing initial setup operations

Before using your receiver for the first time, adjust SET UP parameters so that the receiver correspond to your system. For the adjustable parameters, see the table on page 46. See pages 15–19 for speaker settings and page 33 for other settings.

Multi channel surround setup

For the best possible surround sound, all speakers should be the same distance from the listening position (A).

However, the receiver lets you place the center speaker up to 5 feet closer (B) and the surround speakers up to 15 feet closer (C) to the listening position.

The front speakers can be placed from 3 to 23 feet from the listening position (A).

You can place the surround speakers either behind you or to the side, depending on the shape of your room (etc.). However, we recommend that you place the surround speakers behind you.

When placing surround speakers to your side (long room)

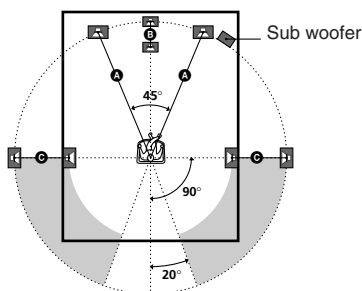

continued

Multi channel surround setup (continued)

When placing surround speakers behind you
(wide room)

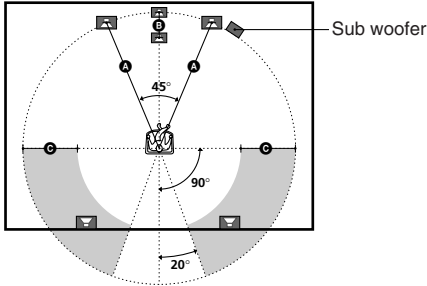

Note

Do not place the center speaker further away from the listening position than the front speakers.

Normal Speaker and Micro Satellite Speaker

For HT-DDW650, the speaker size and the sub woofer selection has been preset to “MICRO SP.” (Micro Satellite Speaker) according to the supplied speaker system.

When you select “MICRO SP.”, the speaker size and sub woofer selection has been configured as follows:

Speaker	Settings
FRONT	SMALL
CENTER	SMALL
SURROUND	SMALL
SUB WOOFER	YES

You cannot change the configuration if you select “MICRO SP.”.

If you change the speaker system, select “NORM. SP.”. You can adjust the speaker size and sub woofer selection when you select “NORM. SP.” (page 18).

To select “NORM. SP.”, turn off the power, then turn on again while pressing MAIN MENU. (To reset to “MICRO SP.”, do the same procedure.)

Tip

The setting for Micro Satellite Speaker (MICRO SP.) has been programmed to optimize the sound balance. If you use Sony’s Micro Satellite Speakers, select “MICRO SP.”.

Caution

When you use Micro Satellite Speakers and the speaker size is set to “LARGE”, you may not obtain the correct soundstage. The speaker may also be damaged at high volume position.

Specifying the speaker parameters

- 1 Press MAIN MENU repeatedly to select “<SET UP>”.
- 2 Press MENU < or MENU > to select the parameter you want to adjust.
- 3 Press MENU + or MENU – to select the setting you want.
The setting is entered automatically.
- 4 Repeat steps 2 and 3 until you have set all of the parameters that follow.

Initial settings

Parameter	Initial setting
DIST. XX ft.	10 ft.
DIST. XX ft.	10 ft.
DIST. XX ft.	10 ft.
PL. XXXX	LOW

■ **Front speaker distance** ($\overline{\text{L}}$ $\overline{\text{R}}$) **DIST.**
XX ft.)

Set the distance from your listening position to the front speakers (**A** on page 15).

■ **Center speaker distance** ($\overline{\text{C}}$) **DIST.**
XX ft.)

Set the distance from your listening position to the center speaker. Center speaker distance should be set from a distance equal to the front speaker distance (**A** on page 15) to a distance 5 feet closer to your listening position (**B** on page 15).

■ **Surround speaker distance** ($\overline{\text{SL}}$ $\overline{\text{SR}}$) **DIST.** **XX ft.)**

Set the distance from your listening position to the surround speakers. Surround speaker distance should be set from a distance equal to the front speaker distance (**A** on page 15) to a distance 15 feet closer to your listening position (**C** on page 15).

Tip

The receiver allows you to input the speaker position in terms of distance. However, it is not possible to set the center speaker further than the front speakers. Also, the center speaker cannot be set more than 5 feet closer than the front speakers.

Likewise, the surround speakers can not be set further away from the listening position than the front speakers. And they can be no more than 15 feet closer.

This is because incorrect speaker placement is not conducive to enjoy surround sound.

Please note that, setting the speaker distance closer than the actual location of the speakers will cause a delay in the output of the sound from that speaker. In other words, the speaker will sound like it is further away.

For example, setting the center speaker distance 3~6 feet closer than the actual speaker position will create a fairly realistic sensation of being “inside” the screen. If you cannot obtain a satisfactory surround effect because the surround speakers are too close, setting the surround speaker distance closer (shorter) than the actual distance will create a larger sound stage.

Adjusting these parameter while listening to the sound often results in much better surround sound. Give it a try!

■ **Surround speaker placement** ($\overline{\text{SL}}$ $\overline{\text{SR}}$) **PL.** **XXXX)***

This parameter lets you specify the height of your surround speakers for proper implementation of the Digital Cinema Sound surround modes. Refer to the illustration below.

- Select “PL. LOW” if the location of your surround speakers corresponds to section **A**.
- Select “PL. HIGH” if the location of your surround speakers corresponds to section **B**.

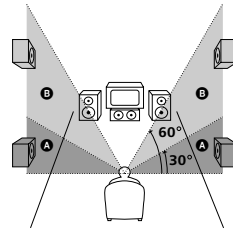

* These parameters are not available when “Surround speaker size ($\overline{\text{SL}}$ $\overline{\text{SR}}$)” is set to “NO”.

continued

Multi channel surround setup (continued)

Tip

The surround speaker placement parameter is designed specifically for implementation of the Digital Cinema Sound modes with virtual elements. With the Digital Cinema Sound modes, speaker placement is not as critical as other modes. All modes with virtual elements were designed under the premise that the surround speaker would be located behind the listening position, but presentation remains fairly consistent even with the surround speakers positioned at a rather wide angle. However, if the speakers are pointing towards the listener from the immediate left and right of the listening position, the sound fields with virtual elements will not be as effective.

Nevertheless, each listening environment has many variables, like wall reflections.

Therefore, we recommend that you playback multi channel surround encoded software and listen to the effect each setting has on your listening environment. Choose the setting that provides a good sense of spaciousness and that best succeeds in forming a cohesive space between the surround sound from the surround speakers and the sound of the front speakers. If you are not sure which sounds best, select "PL. LOW" and then use the speaker distance parameter and speaker level adjustments to obtain proper balance.

Only when you use the speaker system other than the supplied one, be sure to set the following parameters.

For details on "NORM. SP." (Normal Speaker), see page 16.

■ Sub woofer selection (S.W. XXX)

- If you connect a sub woofer, select "YES".
- If you do not connect a sub woofer, select "NO". This activates the bass redirection circuitry and outputs the LFE signals from other speakers.

■ Front speaker size (XXXXX)

- If you connect large speakers that will effectively reproduce bass frequencies, select "LARGE". Normally, select "LARGE".
- If the sound is distorted, or you feel a lack of surround effects when using multi channel surround sound, select "SMALL" to activate the bass redirection circuitry and output the front channel bass frequencies from the sub woofer.
- When the front speakers are set to "SMALL", the center and surround speakers are also automatically set to "SMALL" (unless previously set to "NO").
- When the sub woofer is set to "NO", the front speakers are automatically set to "LARGE" and you cannot change this setting.

■ Center speaker size (XXXXX)

- If you connect a large speaker that will effectively reproduce bass frequencies, select "LARGE". Normally, select "LARGE". However, if the front speakers are set to "SMALL", you cannot set the center speaker to "LARGE".
- If the sound is distorted, or you feel a lack of surround effects when using multi channel surround sound, select "SMALL" to activate the bass redirection circuitry and output the center channel bass frequencies from the front speakers (if set to "LARGE") or sub woofer.*¹
- If you do not connect a center speaker, select "NO". The sound of the center channel will be output from the front speakers.*²

■ Surround speaker size (XXXXX)

- If you connect large speakers that will effectively reproduce bass frequencies, select “LARGE”. Normally, select “LARGE”. However, if the front speakers are set to “SMALL”, you cannot set the surround speakers to “LARGE”.
- If the sound is distorted, or you feel a lack of surround effects when using multi channel surround sound, select “SMALL” to activate the bass redirection circuitry and output the surround channel bass frequencies from the sub woofer or other “LARGE” speakers.
- If you do not connect surround speakers, select “NO”.*3

Tip

*1-3 correspond to the following Dolby Pro Logic modes

- *1 NORMAL
- *2 PHANTOM
- *3 3 STEREO

Tip

Internally, the LARGE and SMALL settings for each speaker determine whether the internal sound processor will cut the bass signal from that channel. When the bass is cut from a channel, the bass redirection circuitry sends the corresponding bass frequencies to the sub woofer or other “LARGE” speakers.

However, since bass sounds have a certain amount of directionality, it is best not to cut them, if possible. Therefore, even when using small speakers, you can set them to “LARGE” if you want to output the bass frequencies from that speaker. On the other hand, if you are using a large speaker, but prefer not to have bass frequencies output from that speaker, set it to “SMALL”.

If the overall sound level is lower than you prefer, set all speakers to “LARGE”. If there is not enough bass, you can use the BASS parameter in the TONE menu to boost the bass levels. To adjust the bass, see page 28.

Adjusting the speaker level

Use the remote while seated in your listening position to adjust the level of each speaker.

Note

The receiver incorporates a new test tone with a frequency centered at 800 Hz for easier speaker level adjustment.

1 Press I/⏻ on the remote to turn on the receiver.

2 Press T.TONE on the remote.

“T. TONE” appears in the display and you will hear the test tone from each speaker in sequence.

Front (left) → Center → Front (right) →
Surround (right) → Surround (left) →
Sub woofer

3 Adjust the speaker level and balance using the LEVEL menu so that the level of the test tone sounds the same from each speaker.

For details on the LEVEL menu, see page 27.

While adjusting, the test tone is output from the speaker whose adjustment is performed.

4 Press T.TONE again to turn off the test tone.

Tip

You can adjust the level of all speakers at the same time. Press MASTER VOL +/- on the remote or turn MASTER VOLUME on the receiver.

Notes

- The adjusted value are shown in the display during adjustment.
- Although these adjustments can also be made via the front panel using the LEVEL menu (when the test tone is output, the receiver switches to the LEVEL menu automatically), we recommend you follow the procedure described above and adjust the speaker levels from your listening position using the remote.

continued

Multi channel surround setup (continued)

Listening to the sub woofer

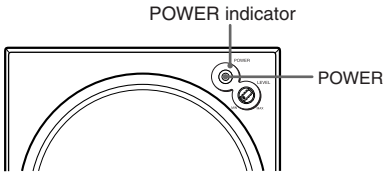

First, turn down the volume on the receiver. The volume should be set to minimum before you begin playing the program source.

1 Turn on the receiver and select the program source.

2 Press POWER on the sub woofer.

The POWER indicator on the sub woofer lights up in green.

3 Play the program source.

Adjusting the sound

Slight adjustments to the system can enhance your sound enjoyment.

Adjusting the sub woofer

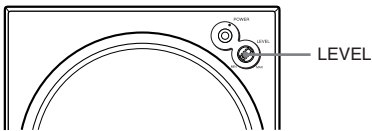

1 Rotate LEVEL to adjust the volume.

Set the volume level to best suit your preference according to the program source.

Note

Do not turn the volume of the woofer to maximum. Extraneous noise may be heard.

Checking the connections

After connecting all of your components to the receiver, do the following to verify that the connections were made correctly.

1 Press I/⏻ to turn on the receiver.

2 Turn on the component that you connected (e.g., CD player or tape deck).

3 Press the input selector button (e.g., CD or MD/TAPE) to select the component (program source).

4 Start playing.

If you do not obtain normal sound output after performing this procedure, see “Troubleshooting” on page 40 and take the appropriate measures to correct the problem.

Selecting the component

Input Selector buttons

Press the input selector button to select the component you want to use.

To select	Press
DVD PLAYER/VIDEO CASSETTE RECORDER (DVD mode)	DVD
DVD PLAYER/VIDEO CASSETTE RECORDER (VIDEO mode)	VIDEO 1
Other VCR	VIDEO 2
MD or Tape deck	MD/TAPE
CD player	CD
Built in tuner	TUNER FM/AM

After turning on the component you selected, select the component and play the program source.

- After selecting DVD PLAYER/VIDEO CASSETTE RECORDER, VCR or DVD player, turn on the TV and set the TV's video input to match the component you selected.

INPUT MODE

Press INPUT MODE to select the input mode for your digital components.

Each time you press the button, the input mode of the currently selected component switches.

Select	To
AUTO IN	Give priority to digital signals when there are both digital and analog connections. If there are no digital signals, analog is selected.
COAX IN	Specify the digital audio signals input to the DIGITAL COAXIAL input jacks.

Select	To
OPT IN	Specify the digital audio signals input to the DIGITAL OPTICAL input jacks.
ANALOG	Specify the analog audio signals input to the AUDIO IN (L/R) jacks.

Note

When the 96 kHz digital signal is input, the tone, sound field and effect level do not function.

MUTING

Press MUTING on the remote to mute the sound. Press again to cancel the muting function. The muting function is also canceled when you turn the power on or turn the MASTER VOLUME to turn the volume up.

PHONES

Use to connect headphones.

- When the headphones are connected, speaker output is automatically canceled and "SP" do not light up in the display.

Changing the display

DIMMER

Press DIMMER repeatedly to adjust the brightness of the display (3 steps). However, when you press any button, the display becomes the brightest setting temporary.

DISPLAY

Each time you press DISPLAY, the display changes cyclically as follows:

Index name of the component* → Selected component → Sound field applied to the program source

When the tuner is selected

Index name of the preset station* → Frequency → Sound field applied to the band or the preset station

* Index name appears only when you have assigned one to the component or preset station (page 32). Index name does not appear when only blank spaces have been entered, or it is the same as the input selector.

You can take advantage of surround sound simply by selecting one of the receiver's pre-programmed sound fields. They bring the exciting and powerful sound of movie theaters and concert halls into your home. You can also customize the sound fields to obtain the sound you want by changing the surround parameter. To fully enjoy surround sound, you must register the number and location of your speakers. See "Multi channel surround setup" starting from page 15 to set the speaker parameters before enjoying surround sound.

Using only the front speakers (2 Channel Stereo)

Press 2CH.

The 2CH indicator lights up and "2CH ST." appears in the display.

This mode outputs the sound from the front left and right speakers only. Standard 2 channel (stereo) sources completely bypass the sound field processing. Multi channel surround formats are downmixed to 2 channel.

Notes

- No sound is output from the sub woofer when "2CH ST." is selected. To listen to 2 channel (stereo) sources using the front left and right speakers and a sub woofer, press A.F.D. repeatedly to select "A.F.D. AUTO".
- When you select "Micro Satellite Speaker" (page 16), internal sound processor will automatically redirect bass sound to sub woofer. If you want to listen to two channel (stereo) sources under this setting, we recommend that you choose "A.F.D. AUTO" mode so that you can take advantage of your sub woofer to obtain the correct bass signal.

Enjoying higher fidelity sound

The Auto Format Direct (A.F.D.) mode allows you to select the decoding mode you want for your audio sound.

Mode	Decoding Mode
A.F.D. AUTO	As encoded
DOLBY PL	Dolby Pro Logic
PLII MOV	Dolby Pro Logic II
PLII MUS	

Decoding the input audio signal automatically

Press A.F.D. repeatedly to select "A.F.D. AUTO".

The A.F.D. indicator lights up.

This mode automatically detects the type of audio signal being input (Dolby Digital, DTS, or standard 2 channel stereo) and performs the proper decoding if necessary. This mode presents the sound as it was recorded/encoded, without adding any effects (e.g. reverberation).

However, if there are no low frequency signals (Dolby Digital LFE, etc.) it will generate a low frequency signal for output to the sub woofer.

continued

Enjoying higher fidelity sound (continued)

Enjoying stereo sound in multi channel (Dolby Pro Logic II)

This receiver incorporates with Dolby Pro Logic II which has movie mode and music mode, and the receiver can reproduce the 2 channel sound in 5.1 channel through Dolby Pro Logic II.

Press A.F.D. repeatedly to select “DOLBY PL”, “PL II MOV” or “PL II MUS”.

The A.F.D. indicator lights up and the selected type of decoding is indicated in the display.

■ DOLBY PL (Dolby Pro Logic)

Performs the Pro Logic decoding. Software with multi channel surround audio signals is played back according to the way it was recorded. Software with 2 channel audio signals is decoded with Dolby Pro Logic to create surround effects (4 channels).

■ PL II MOV (Pro Logic II Movie)

Performs the Pro Logic II movie mode decoding. This setting is ideal for the movies encoded in Dolby Surround. Besides, this mode can reproduce the sound in 5.1 channel when watching the videos of old movies or in the dubbed language.

■ PL II MUS (Pro Logic II Music)

Performs the Pro Logic II music mode decoding. This setting is ideal for the normal stereo sources, such as CDs.

Note

Dolby Pro Logic and Dolby Pro Logic II decoding does not function for DTS format signals.

Selecting a sound field

You can enjoy surround sound simply by selecting one of the pre-programmed sound fields according to the program you want to listen to.

Press	To select
MOVIE	C.ST.EX A DCS *
	C.ST.EX B DCS *
	C.ST.EX C DCS *
MUSIC	HALL
	JAZZ
	CONCERT

* Sound field with **DCS** mark use DCS technology.

About DCS (Digital Cinema Sound)

In collaboration with Sony Pictures Entertainment, Sony measured the sound environment of their studios and integrated the data of the measurement and Sony's own DSP (Digital Signal Processor) technology to develop "Digital Cinema Sound". In a home theater, "Digital Cinema Sound" simulates an ideal movie theater sound environment based on the preference of the movie director.

Enjoying movies with Cinema Studio EX

Cinema Studio EX is ideal for enjoying the movie software encoded with multi channel format, such as the Dolby Digital DVD. This mode reproduces the sound characteristics of Sony Pictures Entertainment's studios.

Press MOVIE repeatedly to select “C.ST.EX A”, “C.ST.EX B” or “C.ST.EX C”.

The MOVIE indicator lights up and the selected sound field is indicated in the display.

■ C.ST.EX A (Cinema Studio EX A)

Reproduces the sound characteristics of the Sony Pictures Entertainment “Cary Grant Theater” cinema production studio. This is a standard mode, great for watching most any type of movie.

■ C.ST.EX B (Cinema Studio EX B)

Reproduces the sound characteristics of the Sony Pictures Entertainment “Kim Novak Theater” cinema production studio. This mode is ideal for watching science-fiction or action movies with lots of sound effects.

■ C.ST.EX C (Cinema Studio EX C)

Reproduces the sound characteristics of the Sony Pictures Entertainment scoring stage. This mode is ideal for watching musicals or classic films where music is featured in the soundtrack.

About Cinema Studio EX

Cinema Studio EX consists of the following three elements.

• Virtual Multi Dimension

Creates 5 sets of virtual speakers surrounding the listener from a single pair of actual surround speakers.

• Screen Depth Matching

In a movie theater, sound seems to come from inside the image reflected on the movie screen. This element creates the same sensation in your listening room by shifting the sound of the front speakers “into” the screen.

• Cinema Studio Reverberation

Reproduces the reverberations peculiar to a movie theater.

Cinema Studio EX is the integrated mode which operates these elements simultaneously.

Notes

- The effects provided by the virtual speakers may cause increased noise in the playback signal.
- When listening with sound fields that employ the virtual speakers, you will not be able to hear any sound coming directly from the surround speakers.

Selecting other sound fields

Press MUSIC repeatedly to select the sound field you want.

The MUSIC indicator lights up and the current sound field is indicated in the display.

■ HALL

Reproduces the acoustics of a rectangular concert hall.

■ JAZZ (Jazz Club)

Reproduces the acoustics of a jazz club.



■ CONCERT (Live Concert)

Reproduces the acoustics of a 300-seat live concert.

To turn the surround effect off

Press A.F.D. repeatedly to select “A.F.D. AUTO” or press 2CH.

Tips

- The receiver lets you apply the last selected sound field to a program source whenever it is selected (Sound Field Link). For example, if you listen to CD with “JAZZ” as the sound field, change to a different program source, then return to CD, “JAZZ” will be applied again.
- You can identify the encoding format of DVD software, etc. by looking at the logo on the package.
 - : Dolby Digital discs
 - : Dolby Surround encoded programs
 - : DTS Digital Surround encoded programs
- When sound signals with a sampling frequency of 96 kHz are input, the sound signals are output in stereo automatically, and the sound field is turned off.

Understanding the multi channel surround displays

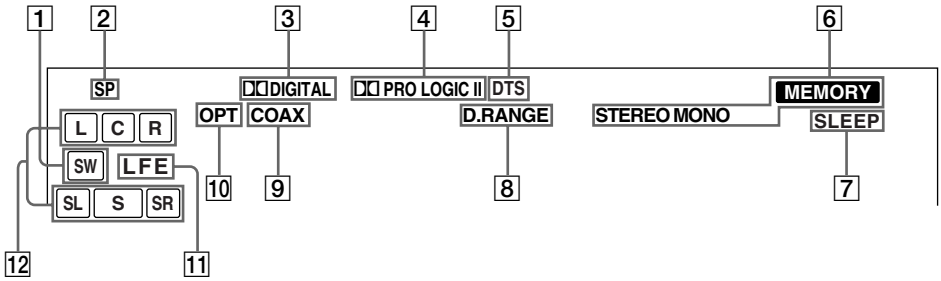

- 1 SW:** Lights up when sub woofer selection is set to “YES” (page 18) and the audio signal is output from the SUB WOOFER jacks.

- 2 SP:** Lights up when you turn on the receiver.

Note

Does not light up when you connect headphones to the PHONES jack.

- 3 DIGITAL:** Lights up when the receiver is decoding signals recorded in the Dolby Digital format.

- 4 PRO LOGIC II:** “ PRO LOGIC” lights up when the receiver applies Pro Logic processing to 2 channel signals in order to output the center and surround channel signals. “ PRO LOGIC II” lights up when Pro Logic II processing (“PLII MOV” or “PLII MUS”) is applied (page 24). However, both indicators do not light up if the center and surround speakers are set to “NO”, and “A.F.D. AUTO”, “DOLBY PL”, “PLII MOV” or “PLII MUS” is selected.

Note

Dolby Pro Logic and Dolby Pro Logic II decoding does not function for DTS format signals.

- 5 DTS:** Lights up when DTS signals are input.

Note

When playing a DTS format disc, be sure that you have made digital connections and that INPUT MODE is NOT set to “ANALOG” (page 21).

- 6 Tuner indicators:** Lights up when using the receiver to tune in radio stations, etc. See pages 29 – 31 for tuner operations.

- 7 SLEEP:** Lights up when sleep timer is activated.

- 8 D.RANGE:** Lights up when dynamic range compression is activated. See page 27 to adjust the dynamic range compression.

- 9 COAX:** Lights up when the source signal is a digital signal being input through the COAXIAL terminal.

- 10 OPT:** Lights up when the source signal is a digital signal being input through the OPTICAL terminal.

- 11 LFE:** Lights up when the disc being played back contains the LFE (Low Frequency Effect) channel and when the sound of the LFE channel signal is actually being reproduced.

12 Playback channel indicators: The letters (L, C, R, etc.) indicate the channels being played back. The boxes around the letters vary to show how the receiver downmixes the source sound (based on the speakers settings). When using sound fields like “C.ST.EX”, the receiver adds reverberation based on the source sound.

L (Front Left), R (Front Right), C (Center (monaural)), SL (Surround Left), SR (Surround Right), S (Surround (monaural or the surround components obtained by Pro Logic processing)).

Example:

Recording format (Front /Surround): 3/2
 Output channel: Surround speakers absent
 Sound Field: A.F.D. AUTO



SL SR

Customizing sound fields

By adjusting the surround parameters and the tone characteristics of the front speakers, you can customize the sound fields to suit your particular listening situation.

Once you customize a sound field, the changes are stored in the memory indefinitely. You can change a customized sound field any time by making new adjustments to the parameters.

See the tables on page 47 for the parameters available in each sound field.

To get the most from multi channel surround sound

Position your speakers and do the procedures described in “Multi channel surround setup” starting from page 15 before you customize a sound field.

Adjusting the level parameters

The LEVEL menu contains parameters that let you adjust the balance and volumes of each speaker. You can also customize various aspects of the current sound field. The settings are applied to all sound fields except for EFCT. parameter. For EFCT. parameter, the settings are stored individually for each sound field.

- 1 Start playing a program source encoded with multi channel surround sound.**
- 2 Press MAIN MENU repeatedly to select “<LEVEL>”.**
- 3 Press MENU < or MENU > to select the parameter you want to adjust.**
- 4 Press MENU + or MENU – to select the setting you want.**

The setting is entered automatically.

Initial settings

Parameter	Initial setting
BAL. L/R XX	BALANCE
CTR XXX dB	0 dB
SUR.L. XXX dB	0 dB
SUR.R. XXX dB	0 dB
S.W. XXX dB	0 dB
COMP. XXX	OFF
EFCT. XXX	STD

continued

Customizing sound fields (continued)

Front balance (BAL. L/R XX)

Lets you adjust the balance between front left and right speakers.

Center level (CTR XXX dB)

Lets you adjust the level of the center speaker.

Surround left level (SUR.L. XXX dB)

Lets you adjust the level of the surround left speaker.

Surround right level (SUR.R. XXX dB)

Lets you adjust the level of the surround right speaker.

Sub woofer level (S.W. XXX dB)

Lets you adjust the level of the sub woofer.

Dynamic range compressor (D. RANGE COMP. XXX)

Lets you compress the dynamic range of the sound track. This may be useful when you want to watch movies at low volumes late at night. We recommend using the “MAX” setting.

- To reproduce the sound track with no compression, select “OFF”.
- To reproduce the sound track with the dynamic range intended by the recording engineer, select “STD”.
- To reproduce a dramatic compression of the dynamic range, select “MAX”.

Note

Dynamic range compression is possible with Dolby Digital sources only.

Effect level (EFCT. XXX)

Lets you adjust the “presence” of the current surround effect.

Adjusting the tone parameters

The TONE menu contains parameters that lets you adjust the tone of the front speakers for optimum sound. The settings are applied to all sound fields.

- 1 Start playing a program source encoded with multi channel surround sound.**
- 2 Press MAIN MENU repeatedly to select “<TONE>”.**
- 3 Press MENU < or MENU > to select the parameter you want to adjust.**
- 4 Press MENU + or MENU – to select the setting you want.**
The setting is stored automatically.

Initial settings

Parameter	Initial setting
BASS XX dB	0 dB
TREB. XX dB	0 dB

Bass (BASS XX dB)

Lets you adjust the bass tone.

Treble (TREB. XX dB)

Lets you adjust the treble tone.

Note

When you use the Micro Satellite Speakers or other small speakers, adjust LEVEL on the subwoofer (page 20) to reinforce the bass.

Resetting customized sound fields to the factory settings

- 1 If the power is on, press I/⏻ to turn off the power.**
- 2 Hold down 2CH and press I/⏻.**
“SF. CLR.” appears in the display and all sound fields are reset at once.

Before receiving broadcasts, make sure you have connected FM and AM antennas to the receiver (page 7).

Direct tuning

You can enter a frequency of the station you want directly by using the numeric buttons on the supplied remote. For details on the buttons used in this section, see pages 35–39.

1 Press TUNER on the remote repeatedly to select the FM or AM band.

The last received station is tuned in.

2 Press D. TUNING on the remote.

3 Press the numeric buttons to enter the frequency.

Example 1: FM 102.50 MHz

① → ② → ⑤ → ①

Example 2: AM 1350 kHz
(You don't have to enter the last "0" when the tuning scale is set to 10 kHz.)

① → ③ → ⑤ → ①

If you cannot tune in a station and the entered numbers flash

Make sure you've entered the right frequency. If not, repeat steps 2 and 3.

If the entered numbers still flash, the frequency is not used in your area.

4 If you've tuned in an AM station, adjust the direction of the AM loop antenna for optimum reception.

5 Repeat steps 1 to 4 to receive another station.

Tips

- If you do not remember the precise frequency, press TUNING + or TUNING – after entering the value close to the frequency you want. The receiver automatically tunes in the station you want. If the frequency seems to be higher than the entered value, press TUNING +, and if the frequency seems to be lower than the entered value, press TUNING –.
- If "STEREO" flashes in the display and the FM stereo reception is poor, press FM MODE to change to monaural (MONO). You will not be able to enjoy the stereo effect, but the sound will be less distorted. To return to stereo mode, press FM MODE again.

The tuning scale is:

FM: 100kHz

AM: 10 kHz*

* The AM tuning scale can be changed (page 44).

Automatic tuning

If you don't know the frequency of the station you want, you can let the receiver scan all available stations in your area.

1 Press TUNER FM/AM repeatedly to select the FM or AM band.

The last received station is tuned in.

2 Press TUNING + or TUNING –.

Press TUNING + to scan from low to high; press TUNING – to scan from high to low.

The receiver stops scanning whenever a station is received.

When the receiver reaches either end of the band

Scanning is repeated in the same direction.

3 To continue scanning, press TUNING + or TUNING – again.

Preset tuning

After you have tuned in stations using Direct Tuning or Automatic Tuning, you can preset them to the receiver. Then you can tune in any of the stations directly by entering its 2-character preset code using the supplied remote. Up to 30 FM or AM stations can be preset. The receiver will also scan all the stations that you have preset.

Before tuning to preset stations, be sure to preset them by performing steps on "Presetting radio stations".

Presetting radio stations

1 Press TUNER FM/AM.

The last received station is tuned in.

2 Tune in the station that you want to preset using Direct Tuning (page 29) or Automatic Tuning (page 30).

3 Press MEMORY.

"MEMORY" appears in the display for a few seconds.

Do steps 4 to 5 before "MEMORY" goes out.

4 Press PRESET TUNING + or PRESET TUNING – repeatedly to select a preset station number.

Each time you press the button, the preset station number changes in the corresponding number and direction as follows:

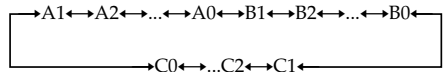

If "MEMORY" goes out before you select the preset station number, start again from step 3.

5 Press MEMORY again to store the station.

If "MEMORY" goes out before you can store the station, start again from step 3.

6 Repeat steps 2 to 5 to preset another station.

To change a preset number to another station

Do steps 1 to 5 to preset a new station to the number.

Tip

In step 4, you can also use the remote to select a preset station number. Press SHIFT repeatedly to select a memory page (A, B or C) and then press the numeric buttons to select a preset number.

Tuning to preset stations

You can tune the preset stations by either of the following two ways.

Scanning the preset stations

1 Press TUNER FM/AM.

The last received station is tuned in.

2 Press PRESET TUNING + or PRESET TUNING – repeatedly to select the preset station you want.

Each time you press the button, the receiver tunes in one preset station at a time, in the corresponding order and direction as follows:

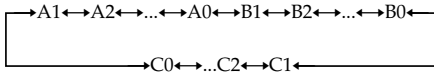

Using the preset codes

Use the supplied remote to perform the following operations. For details on the buttons used in this section, see pages 35–39.

1 Press TUNER on the remote.

The last received station is tuned in.

2 Press SHIFT to select a memory page (A, B, or C), then press the preset number of the station you want using the numeric buttons.

Naming preset stations and program sources

You can enter a name (index name) of up to 8 characters for preset stations and program sources. These names (for example, "VHS") appear in the receiver's display when a station or program source is selected. Note that no more than one name can be entered for each preset station or program source.

This function is useful for distinguishing components of the same kind. For example, two VCRs can be specified as "VHS" and "8MM", respectively. It is also handy for identifying components connected to jacks meant for another type of component, for example, a second CD player connected to the MD/TAPE jacks.

1 To name a preset station

Press **TUNER FM/AM**, then tune in the preset station you want to create an index name for.

If you are not familiar with how to tune in preset stations, see "Tuning to preset stations" on page 31.

To name a program source

Select the program source (component) to be named.

2 Press MAIN MENU repeatedly to select "<NAME>".

3 Create an index name by using MENU + or MENU – and MENU < or MENU >:

Press MENU + or MENU – to select a character, then press MENU > to move the cursor to the next position.

To insert a space

Press MENU + or MENU – until a blank space appears in the display.

If you've made a mistake

Press MENU < or MENU > repeatedly until the character to be changed flashes, then press MENU + or MENU – to select the character you want.

4 Press ENTER.

5 Repeat steps 2 to 4 to assign index name for another station or program source.

Recording

Before you begin, make sure you've connected all components properly.

Recording on an audio tape or MiniDisc

You can record on a cassette tape or MiniDisc using the receiver. See the operating instructions of your cassette deck or MD deck if you need help.

1 Select the component to be recorded.

2 Prepare the component for playing.

For example, insert a CD into the CD player.

3 Insert a blank tape or MD into the recording deck and adjust the recording level, if necessary.

4 Start recording on the recording deck, then start playback on the playback component.

Notes

- Sound adjustments do not affect the signal output from the MD/TAPE OUT jacks.
- Some sources contain copy guards to prevent recording. In this case, you may not be able to record from the sources.

Recording on a video tape

You can record from a VCR, a TV or a DVD player using the receiver. You can also add audio from a variety of audio sources when editing a video tape. See the operating instructions of your VCR or DVD player if you need help.

- 1** Select the program source to be recorded.
- 2** Prepare the component for playing.
For example, insert the DVD you want to record into the DVD player.
- 3** Insert a blank video tape into the VCR (VIDEO 1) for recording.
- 4** Start recording on the recording VCR, then start playing the video tape or DVD you want to record.

Tip

You can record the sound from any audio source onto a video tape while copying from a video tape or DVD. Locate the point where you want to start recording from another audio source, select the program source, then start playback. The audio from that source will be recorded onto the audio track of the video tape instead of the audio from the original medium. To resume audio recording from the original medium, select the video source again.

Note

Make sure to make both digital and analog connections to the VIDEO 2 and DVD inputs. Analog recording is not possible if you make only digital connections.

Adjustments using the SET UP menu

The SET UP menu allows you to make the following adjustments.

- 1** Press MAIN MENU repeatedly to select “<SET UP>”.
- 2** Press MENU < or MENU > to select the parameter you want to adjust.
- 3** Press MENU + or MENU – to select the setting you want.
The setting is entered automatically.

Initial settings

Parameter	Initial setting
DEC. XXXX	PCM (for DVD), AUTO (for VIDEO 2)

■ Decode priority (DEC. XXXX)

Sets the appropriate decoding for incoming digital signals.

- PCM priority mode (DEC. PCM)
Use to enjoy playback from audio CD (PCM) and DVD. When used with media other than CD or DVD, you may experience noise. If this happens, switch to AUTO mode.
- AUTO mode (DEC. AUTO)
Use to enjoy playback from audio CD (PCM), DVD, DTS-CD and DTS-LD sources. However, with audio CDs, you may not be able to listen the very first moments of each track.

Normally, use as-is with the initial settings above.

Changing the command mode of the receiver

This function is useful when you use 2 Sony receivers in the same room.

1 Turn off the receiver.

2 Hold down ENTER and press I/⏻ to turn on the receiver.

“C.MODE.AVX” appears in the display.

Each time you repeat the procedure above, the display changes as follows:

C.MODE.AV1 ↔ C.MODE.AV2

Tip

The initial setting is “C.MODE.AV2”.

Notes

- The command mode of the supplied remote is “AV2” and you cannot change this setting.
- If the command mode of the receiver and the remote is different, you cannot use the remote to operate the receiver.

Operations Using the Remote RM-PP65

You can use the remote RM-PP65 to operate the components in your system. You can also use this remote to operate the DVD PLAYER/VIDEO CASSETTE RECORDER (SLV-D300P).

Before you use your remote

Inserting batteries into the remote

Insert R6 (size-AA) batteries with the + and - properly oriented in the battery compartment. When using the remote, point it at the remote sensor  on the receiver.

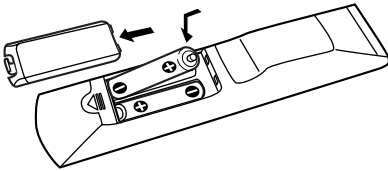

Tip

Under normal conditions, the batteries should last for about 6 months. When the remote no longer operates the receiver, replace all batteries with new ones.

Notes

- Do not leave the remote in an extremely hot or humid place.
- Do not use a new battery with an old one.
- Do not expose the remote sensor to direct sunlight or lighting apparatuses. Doing so may cause a malfunction.
- If you don't use the remote for an extended period of time, remove the batteries to avoid possible damage from battery leakage and corrosion.

Remote button description

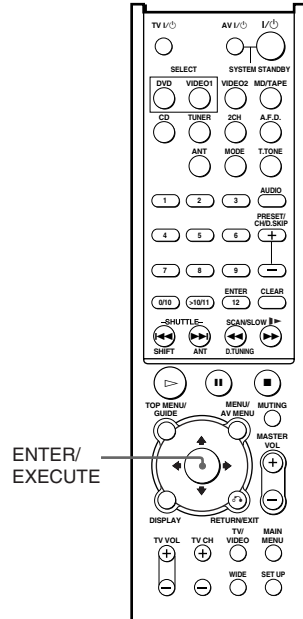

The tables below show the settings of each button.

Remote Button	Operations	Function
I/⏻	Receiver	Turns the receiver on or off.
VIDEO1	Receiver	To watch DVD PLAYER/VIDEO CASSETTE RECORDER (VIDEO mode).
VIDEO2	Receiver	To watch VCR. (VTR mode 3)
DVD	Receiver	To watch DVD PLAYER/VIDEO CASSETTE RECORDER (DVD mode).
MD/TAPE	Receiver	To listen to Minidisc or audio tape.

continued

Remote Button Description (continued)

Remote Button	Operations	Function
CD	Receiver	To listen to compact disc.
TUNER	Receiver	To listen to radio programs.
2CH	Receiver	Selects 2CH ST. mode.
A.F.D.	Receiver	Selects A.F.D. AUTO, DOLBY PL, PLII MOV and PLII MUS.
MODE	Receiver	Selects C.ST.EX A, C.ST.EX B and C.ST.EX C, HALL, JAZZ and CONCERT.
T.TONE	Receiver	Press to output test tone.
SHIFT	Receiver	Press repeatedly to select a memory page for presetting radio stations or tuning to preset stations.
D.TUNING	Receiver	Tuner station direct key-in-mode.
MUTING	Receiver	Mutes the sound from the receiver.
↕/↔	Receiver	Select a menu item.
↔/↕	Receiver	Makes adjustment or change the setting.
MASTER VOL +/-	Receiver	Adjusts the master volume of the receiver.
MAIN MENU	Receiver	Press this button repeatedly to select one of the four cursor modes: SET UP, LEVEL, TONE and NAME.
SET UP	DVD PLAYER/ VIDEO CASSETTE RECORDER	Select the SETUP MENU.
AV I/⏻	TV/ CD player/ DVD PLAYER/ VIDEO CASSETTE RECORDER/ MD deck	Turns the audio and video components on or off.



Remote Button	Operations	Function
SYSTEM STANDBY (Press AV I/⏻ and I/⏻ at the same time)	Receiver/ TV/ Satellite tuner/ CD player/ DVD PLAYER/ VIDEO CASSETTE RECORDER/ MD deck	Turns off the receiver and other Sony audio/video components.
1-9 and 0/10	Receiver	Use with "SHIFT" button to preset radio station or tuning to preset stations and with "D.TUNING" for direct tuning.
	CD player/ MD deck	Select track numbers. 0/10 selects track 10.
	TV/ DVD PLAYER/ VIDEO CASSETTE RECORDER (VIDEO mode)/ Satellite tuner	Select channel numbers.
>10/11	CD player/ MD deck/ Tape deck	Select track numbers over 10.
AUDIO	TV/ DVD PLAYER/ VIDEO CASSETTE RECORDER	Changes the sound to Multiplex, Bilingual or Multi channel TV Sound.
PRESET/CH/	Receiver	Scans and selects preset stations.
D.SKIP +/-	TV/ DVD PLAYER/ VIDEO CASSETTE RECORDER (VIDEO mode)/ Satellite tuner	Selects preset channels.
	CD player/ DVD PLAYER/ VIDEO CASSETTE RECORDER (DVD mode)/ MD deck	Skips discs (multi-disc changer only).

Remote Button	Operations	Function
ENTER	TV/ DVD PLAYER/ VIDEO CASSETTE RECORDER (VIDEO mode)/ Satellite tuner/ MD deck/ Tape deck	After selecting a channel, disc or track using the numeric buttons, press to enter the value.
ANT	DVD PLAYER/ VIDEO CASSETTE RECORDER (VIDEO mode)	Selects output signal from aerial terminal: TV signal or VCR program.
◀◀/▶▶	CD player/ DVD PLAYER/ VIDEO CASSETTE RECORDER/ MD deck/ Tape deck	Skips tracks.
◀◀/▶▶	CD player/ DVD PLAYER/ VIDEO CASSETTE RECORDER (DVD mode)/ MD deck	Searches tracks (forward or backward).
	DVD PLAYER/ VIDEO CASSETTE RECORDER (VIDEO mode)/ Tape deck	Fastforwards or rewinds.
▶	CD player/ DVD PLAYER/ VIDEO CASSETTE RECORDER/ MD deck/ Tape deck	Starts play.
⏸	CD player/ DVD PLAYER/ VIDEO CASSETTE RECORDER/ MD deck/ Tape deck	Pauses play or record. (Also starts recording with components in record standby.)

Remote Button	Operations	Function
■	CD player/ DVD PLAYER/ VIDEO CASSETTE RECORDER/ MD deck/ Tape deck	Stops play.
DISPLAY	TV/ DVD PLAYER/ VIDEO CASSETTE RECORDER	Selects information displayed on the TV screen.
RETURN/ EXIT	DVD PLAYER/ VIDEO CASSETTE RECORDER (DVD mode) Satellite tuner	Returns to the previous menu. Exits the menu.
CLEAR	DVD PLAYER/ VIDEO CASSETTE RECORDER (DVD mode)	Press if you made a mistake when you press the number button or press to return to the continuous play etc.
SHUTTLE	DVD PLAYER/ VIDEO CASSETTE RECORDER	Change the playback speed.
SCAN/ SLOW ▶	DVD PLAYER/ VIDEO CASSETTE RECORDER	Play in slow motion.
TOP MENU/ GUIDE	DVD PLAYER/ VIDEO CASSETTE RECORDER (DVD mode) Satellite tuner	Displays DVD title. Displays guide menu.
MENU/ AV MENU	Satellite tuner/ DVD PLAYER/ VIDEO CASSETTE RECORDER	Displays menu.

continued

Remote Button Description (continued)

Remote Button	Operations	Function
	DVD PLAYER/ VIDEO CASSETTE RECORDER (DVD mode)	Returns to the previous menu or exits the menu.
	Satellite tuner/ DVD PLAYER/ VIDEO CASSETTE RECORDER	Selects a menu item.
ENTER/ EXECUTE	Satellite tuner/ DVD PLAYER/ VIDEO CASSETTE RECORDER	Press to enter the selection.
TV I/ 	TV	Turns the TV on or off.
TV VOL +/-	TV	Adjust the volume of the TV.
TV CH +/-	TV	Select preset TV channels.
TV/ VIDEO	TV	Selects input signal: TV input or video input.
WIDE	TV	Selects the wide picture mode.

Notes

- Some functions explained in this section may not work depending on the model of the receiver.
- The above explanation is intended to serve as an example only. Therefore, depending on the component the above operation may not be possible or may operate differently than described.
- Press MAIN MENU on the remote before you use the  buttons for receiver operation.
- Press TOP MENU/GUIDE or MENU/AV MENU on the remote before you use the remote to control the satellite tuner and DVD PLAYER/VIDEO CASSETTE RECORDER.
- The >10/11 and 12 functions are not available for set operation.

Changing the factory setting of an input selector button

If the factory settings of the input selector buttons do not match your system components, you can change them. For example, if you have a tape deck and you do not have an MD deck, you can assign the MD/TAPE button to your tape deck.

Note that the settings of the DVD and VIDEO1 button cannot be changed.

1 Hold down the input selector button whose input source you want to change (for example, MD/TAPE).

2 Press the corresponding numeric codes of the component you want to assign to the input selector button (for example, 25 – Tape deck B).

The following numeric codes are assigned to select the input source:

To operate	Code(s)
CD player	22
MD deck	23
Tape deck A	24
Tape deck B	25
VCR (command mode VTR 2*)	26
VCR (command mode VTR 3*)	27
TV (SONY)	01
DSS (Digital Satellite Receiver)	30
DVD	21
Tuner	28 or 29

* Sony VCRs are operated with a VTR 2 or 3 setting. These correspond to 8mm and VHS respectively.

Now you can use the MD/TAPE button to control the Tape Deck B.

To reset a button to its factory setting

Repeat the above procedure.

To reset all the input selector buttons to their factory setting

Press I/⏻, AV I/⏻ and MASTER VOL – at the same time.

Controlling other TVs with the remote commander

The remote commander is pre-programmed to control non-Sony TVs. If your TV is listed in the following table, set the appropriate manufacturer's code number.

1 Hold down TV I/⏻ and enter your TV's code number using the number buttons. Then release TV I/⏻.

Now you can use the TV I/⏻, VOL +/-, CH +/-, TV/VIDEO and WIDE buttons to control your TV.

Code numbers of controllable TVs

If there is more than one code number listed, try entering them one at a time until you find the one that works with your TV.

TV Maker	Code(s)
SONY	01
AKAI	04
AOC	04
CENTURION	12
CORONADO	03
CURTIS-MATHES	12
DAYTRON	12
EMERSON	03, 04, 14
FISHER	11
GENERAL ELECTRIC	06, 10
GOLD STAR	03, 04, 17
HITACHI	02, 03
J.C.PENNEY	04, 12
JVC	09
KMC	03
MAGNAVOX	03, 08, 12
MARANTZ	04, 13
MGA/MITSUBISHI	04, 12, 13, 17
NEC	04, 12
PANASONIC	06, 19
PHILCO	03, 04
PHILIPS	08
PIONEER	16
PORTLAND	03
QUASAR	06, 18
RADIO SHACK	05, 14
RCA	04, 10
SAMPO	12
SANYO	11
SCOTT	12
SEARS	07, 10, 11
SHARP	03, 05, 18
SYLVANIA	08, 12
TEKNIKA	03, 08, 14
TOSHIBA	07
WARDS	03, 04, 12
YORX	12
ZENITH	15

Notes

- If you enter a new code number, the code number previously entered will be erased.
- When you replace the batteries of the remote commander, the code number may change. Set the appropriate code number every time you replace the batteries.

Precautions

On safety

Should any solid object or liquid fall into the cabinet, unplug the receiver and have it checked by qualified personnel before operating it any further.

On power sources

- Before operating the unit, check that the operating voltage is identical with your local power supply. The operating voltage is indicated on the nameplate at the rear of the receiver.
- The unit is not disconnected from the AC power source (mains) as long as it is connected to the wall outlet, even if the receiver itself has been turned off.
- If you are not going to use the receiver for a long time, be sure to disconnect the receiver from the wall outlet. To disconnect the AC power cord, grasp the plug itself; never pull the cord.
- One blade of the plug is wider than the other for the purpose of safety and will fit into the wall outlet only one way. If you are unable to insert the plug fully into the outlet, contact your dealer.
- AC power cord must be changed only at the qualified service shop.

On heat buildup

Although the unit heats up during operation, this is not a malfunction. If you continuously use this unit at a large volume, the cabinet temperature of the top, side and bottom rises considerably. To avoid burning yourself, do not touch the cabinet.

On placement

- Place the receiver in a location with adequate ventilation to prevent heat buildup and prolong the life of the receiver.
- Do not place the receiver near heat sources, or in a place subject to direct sunlight, excessive dust or mechanical shock.
- Do not place anything on top of the cabinet that might block the ventilation holes and cause malfunctions.
- Use caution when placing the unit or speakers on surfaces that have been specially treated (with wax, oil, polish, etc.) as staining or discoloration of the surface may result.

On operation

Before connecting other components, be sure to turn off and unplug the receiver.

If you encounter color irregularity on a nearby TV screen

This speaker system is magnetically shielded to allow it to be installed near a TV set. However, color irregularities may still be observed on certain types of TV sets.

If color irregularity is observed...

Turn off the TV set once, then turn it on again after 15 to 30 minutes.

If color irregularity is observed again...

Place the speaker further away from the TV set.

If howling occurs

Reposition the speakers or turn down the volume on the receiver.

On cleaning

Clean the cabinet, panel and controls with a soft cloth slightly moistened with a mild detergent solution. Do not use any type of abrasive pad, scouring powder or solvent such as alcohol or benzene.

If you have any question or problem concerning your receiver, please consult your nearest Sony dealer.

Troubleshooting

If you experience any of the following difficulties while using the receiver, use this troubleshooting guide to help you remedy the problem. Also, see "Checking the connections" on page 20 to verify that the connections are correct.

There is no sound or only a very low-level sound no matter which component is selected.

- Check that the speakers and components are connected securely and correctly.
 - Check that both the receiver and all the components are turned on.
 - Check that the MASTER VOLUME control is not set at "VOL MIN".
 - Press MUTE on the remote to cancel the muting function.
 - Check that the headphones are not connected.
 - The protective device on the receiver has been activated because of a short circuit ("PROTECT" flashes). Turn off the receiver, eliminate the short-circuit problem and turn on the power again.
-

There is no sound from a specific component.

- Check that the component is connected correctly to the audio input jacks for that component.
- Check that the cord(s) used for the connection is (are) fully inserted into the jacks on both the receiver and the component.
- Check that you have selected the correct component on the receiver.

There is no sound from one of the front speakers.

Connect a pair of headphones to the PHONES jack to verify that sound is output from the headphones (page 21).

If only one channel is output from the headphones, the component may not be connected to the receiver correctly. Check that all the cords are fully inserted into the jacks on both the receiver and the component.

If both channels are output from the headphones, the front speaker may not be connected to the receiver correctly. Check the connection of the front speaker which is not outputting any sound.

The left and right sounds are unbalanced or reversed.

- Check that the speakers and components are connected correctly and securely.
- Adjust balance parameters in the LEVEL menu.

There is severe hum or noise.

- Check that the speakers and components are connected securely.
- Check that the connecting cords are away from a transformer or motor, and at least 3 meters away from a TV set or fluorescent light.
- Move your TV away from the audio components.
- The plugs and jacks are dirty. Wipe them with a cloth slightly moistened with alcohol.

There is no sound or only a very low-level sound is heard from the center or / and surround speaker.

- Make sure the sound field function is on (press MOVIE or MUSIC).
 - Select a sound field containing the word “C.ST.EX” (pages 24).
 - Adjust the speaker level (page 19).
 - Make sure the center or/and surround speaker size parameter is set to either “SMALL” or “LARGE” (page 18).
-

There is no sound from the active sub woofer.

- Check that the sub woofer is connected correctly and securely.
- There is no sound output from the SUB WOOFER terminal depending on the sound field (page 47).

The surround effect cannot be obtained.

Make sure the sound field function is on (press MOVIE or MUSIC).

Dolby Digital or DTS multi channel sound is not reproduced.

- Check that the playing DVD, etc. is recorded in Dolby Digital or DTS format.
- When connecting the DVD player, etc. to the digital input jacks of this receiver, check the audio setting (settings for the audio output) of the connected component.

Recording cannot be done.

- Check that the components are connected correctly.
 - Select the source component with input selector button.
 - Make sure that INPUT MODE is set to “ANALOG” (page 21) before recording from a digital component connected to the analog MD/TAPE terminal.
-

continued

Troubleshooting (continued)

The FM reception is poor.

Use a 75-ohm coaxial cable (not supplied) to connect the receiver to an outdoor FM antenna as shown below. If you connect the receiver to an outdoor antenna, ground it against lightning. To prevent a gas explosion, do not connect the ground wire to a gas pipe.

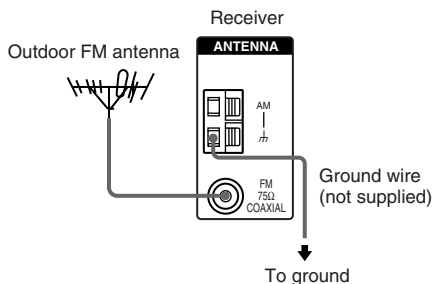



Radio stations cannot be tuned in.

- Check that the antennas are connected securely. Adjust the antennas and connect an external antenna if necessary.
- The signal strength of the stations is too weak (when tuning in with automatic tuning). Use direct tuning.
- Make sure you set the tuning interval correctly (when tuning in AM stations with direct tuning).
- No stations have been preset or the preset stations have been cleared (when tuning by scanning preset stations). Preset the stations (page 30).
- Press DISPLAY so that the frequency appears in the display.

There is no picture or an unclear picture appears on the TV screen or monitor.

- Select the appropriate input selector on the receiver.
- Set your TV to the appropriate input mode.
- Move your TV away from the audio components.

The remote does not function.

- The >10/11 and 12 buttons on the remote are not available.
- Point the remote at the remote sensor  on the receiver.
- Make sure you select AV2 as the command mode of the receiver (page 34).
- Press MAIN MENU on the remote before you use the  buttons for receiver operation.
- Remove any obstacles in the path between the remote and the receiver.
- Replace both batteries in the remote with new ones, if they are weak.
- Make sure you select the correct input selector on the remote.
- If the remote is set to operate the TV only, use the remote to select a source or component other than TV before operating the receiver or other component.

If you are unable to remedy the problem using the troubleshooting guide

Clearing the receiver's memory may remedy the problem (page 15). However, note that all memorized settings will be reset to their factory settings and you will have to readjust all settings on the receiver.

If the problem persists

Consult your nearest Sony dealer.

Clearing the receiver's memory

To clear	See
All memorized settings	page 15
Customized sound fields	page 28

Specifications

AUDIO POWER SPECIFICATIONS

POWER OUTPUT AND TOTAL HARMONIC DISTORTION:

With 8 ohm loads, both channels driven, from 40 – 20,000 Hz; rated 70 watts per channel minimum RMS power, with no more than 0.7 % total harmonic distortion from 250 milliwatts to rated output.

Amplifier section

POWER OUTPUT

Rated Power Output at Stereo Mode

(8 ohms 40 Hz – 20 kHz, THD 0.7 %)
STR-K650P: 70 W + 70 W

Reference Power Output

(8 ohms 1 kHz, THD 0.7 %)
STR-K650P: FRONT¹⁾: 80 W/ch
CENTER¹⁾: 80 W
SURR¹⁾: 80 W/ch

1) Depending on the sound field settings and the source, there may be no sound output.

Frequency response

CD, MD/TAPE, DVD,	10 Hz – 50 kHz
VIDEO 1, 2	+0.5/-2 dB (with sound field and tone bypassed)

Inputs (Analog)

CD, MD/TAPE, DVD,	Sensitivity: 500 mV
VIDEO 1, 2	Impedance: 50 kilohms
	S/N ²⁾ : 96 dB
	(A, 500 mV ³⁾)

2) INPUT SHORT (with sound field and tone bypassed).

3) Weighted network, input level.

Inputs (Digital)

DVD (Coaxial)	Sensitivity: –
	Impedance: 75 ohms
	S/N: 100 dB
	(A, 20 kHz LPF)

VIDEO 2 (Optical)	Sensitivity: –
	Impedance: –
	S/N: 100 dB
	(A, 20 kHz LPF)

Outputs

MD/TAPE (OUT),	Voltage: 500 mV
VIDEO 1	Impedance: 10 kilohms
(AUDIO OUT)	

SUB WOOFER	Voltage: 2 V
	Impedance: 1 kilohms

Tone

Gain levels: ±6 dB, 1 dB step

FM tuner section

Tuning range 87.5 - 108.0 MHz

Antenna terminals 75 ohms, unbalanced

Intermediate Frequency

10.7 MHz

Sensitivity

Mono: 18.3 dBf, 2.2 μV/75 ohms
Stereo: 38.3 dBf, 22.5 μV/75 ohms

Usable sensitivity

11.2 dBf, 1 μV/75 ohms

S/N

Mono: 76 dB
Stereo: 70 dB

Harmonic distortion at 1 kHz

Mono: 0.3%
Stereo: 0.5%

Separation 45 dB at 1 kHz

Frequency response 30 Hz – 15 kHz,
+0.5/-2 dB

Selectivity 60 dB at 400 kHz

continued

Specifications (continued)

AM tuner section

Tuning range

With 10-kHz tuning scale: 530 – 1710 kHz⁴⁾

With 9-kHz tuning scale: 531 – 1710 kHz⁴⁾

Antenna Loop antenna

Intermediate Frequency

450 kHz

Usable sensitivity 50 dB/m (at 1,000 kHz or 999 kHz)

S/N 54 dB (at 50 mV/m)

Harmonic distortion 0.5 % (50 mV/m, 400 Hz)

Selectivity

At 9 kHz: 35 dB

At 10 kHz: 40 dB

- 4) You can change the AM tuning scale to 9 kHz or 10 kHz. After tuning in any AM station, turn off the receiver. Hold down PRESET TUNING + and press I/⏪. All preset stations will be erased when you change the tuning scale. To reset the scale to 10 kHz (or 9 kHz), repeat the procedure.

Video section

Inputs

Video: 1 V_{p-p}, 75 ohms

Outputs

Video: 1 V_{p-p}, 75 ohms

General

Power requirements 120 V AC, 60 Hz

Power consumption 175 W

Power consumption (during standby mode) 0.3 W

Dimensions 16 7/8 × 5 6/8 × 11 6/8 inches including projecting parts and controls

Mass (Approx.) 15 lb 14 oz

Speaker section

SS-MSP75 for front and surround speakers
SS-CNP75 for center speaker

Speaker system Full range, magnetically shielded

Speaker units 70 mm × 100 mm cone type

Enclosure type Bass reflex

Rated Impedance 8 ohms

Power handling capacity (Maximum input power)

100 W

Sensitivity level 86 dB (1 W, 1 m)

Frequency range 160 Hz – 20,000 Hz

Dimensions (w/h/d)

SS-MSP75 Approx. 3 5/8 × 6 × 5 inches

SS-CNP75 Approx. 9 1/8 × 3 5/8 × 5 inches

Mass

SS-MSP75 1 lb 13 oz

SS-CNP75 2 lb 4 oz

SA-WMSP85 for sub woofer

AUDIO POWER SPECIFICATIONS

POWER OUTPUT AND TOTAL HARMONIC DISTORTION:

With 6 ohm loads, from 28 – 200 Hz; rated 100 watts, minimum RMS power, with no more than 0.8% total harmonic distortion from 250 milliwatts to rated output.

Speaker system Active subwoofer, magnetically shielded

Speaker unit Woofer: 20 cm cone type

Enclosure type Acoustically loaded bass reflex

**Continuous RMS power output
(6 ohms, 20 – 250 Hz)**

100 W

Reproduction frequency range

28 Hz – 200 Hz

High frequency cut-off frequency

150 Hz

Input

LINE IN (input pin jacks)

Power requirements

120 V AC, 60 Hz

Power consumption

100 W

Dimensions (w/h/d)

Approx. 10 3/4 × 12 7/8 ×
15 3/4 inches including
front panel

Mass

22 lb 1 oz

Supplied accessories

FM wire antenna (1)

AM loop antenna (1)

Speaker connecting cord, long (2)

Speaker connecting cord, short (3)

Monaural connecting cord (1 phono to 1 phono) (1)

Audio cord (1)

Video cord (1)

Coaxial digital cord (1)

Foot pads (speakers) (20)

Foot pads (subwoofer) (4)

Remote commander (1)

R6 (size -AA) batteries (2)

Speakers

- Front speakers (2)
- Surround speakers (2)
- Center speaker (1)
- Sub woofer (1)

For details on the area code of the component you are using, see page 4.

Design and specifications are subject to change without notice.

Tables of settings using the MAIN MENU button

You can make various settings using the MAIN MENU, MENU < / > and MENU +/- buttons. The tables below show each of the settings that these buttons can make.

Press MAIN MENU repeatedly to select	Press MENU < or MENU > to select	Press MENU + or MENU - to select	Page
<LEVEL>	BAL. L/R XX	L +8 to R +8 (1 steps)	27
	XXX dB	-10 dB to +10 dB (1 dB steps)	
	XXX dB	-10 dB to +10 dB (1 dB steps)	
	XXX dB	-10 dB to +10 dB (1 dB steps)	
	XXX dB	-10 dB to +10 dB (1 dB steps)	
	COMP. XXX	OFF, STD, MAX	
<SET UP>	XXX	depends on the sound field (MIN, STD, MAX)	16
	(SUB WOOFER) S.W. XXX ¹⁾	YES, NO	
	XXXXX ¹⁾	LARGE, SMALL	
	XXXXX ¹⁾	LARGE, SMALL, NO	
	XXXXX ¹⁾	LARGE, SMALL, NO	
	DIST. XX ft.	between 3 feet and 23 feet (1 foot steps)	
	DIST. XX ft.	between DIST. and 5 feet (1 foot steps)	
	DIST. XX ft.	between DIST. and 15 feet (1 foot steps)	
	PL. XXXX	LOW, HIGH	
	XXXX	AUTO, PCM	
<TONE>	BASS XX dB	-6 dB to +6 dB (1 dB step)	28
	TREB. XX dB	-6 dB to +6 dB (1 dB step)	

¹⁾ Only when you select "NORM. SP."

Adjustable parameters for each sound field

The adjusted BASS and TREB. parameters are applied to all sound fields.

	TONE	
	< BASS	> TREB.
2CH ST.	●	●
A.F.D. AUTO	●	●
DOLBY PL	●	●
PLII MOV	●	●
PLII MUS	●	●
C.ST.EX A	●	●
C.ST.EX B	●	●
C.ST.EX C	●	●
HALL	●	●
JAZZ	●	●
CONCERT	●	●
PCM 96K		

The adjusted LEVEL parameters are applied to all the sound fields except for EFCT. parameter. For EFCT. parameter, the settings are stored individually for each sound field.

	LEVEL						
	< FRONT BAL	CENTER LEVEL	SUR.L. LEVEL	SUR.R. LEVEL	S.W. LEVEL	D.RANGE COMP ¹⁾	> EFCT. LEVEL
2CH ST.	●					●	
A.F.D. AUTO	●	●	●	●	●	●	
DOLBY PL	●	●	●	●	●	●	
PLII MOV	●	●	●	●	●	●	
PLII MUS	●	●	●	●	●	●	
C.ST.EX A	●	●	●	●	●	●	●
C.ST.EX B	●	●	●	●	●	●	●
C.ST.EX C	●	●	●	●	●	●	●
HALL	●	●	●	●	● ²⁾	●	●
JAZZ	●	●	●	●	● ²⁾	●	●
CONCERT	●	●	●	●	● ²⁾	●	●
PCM 96K	●						

¹⁾ These parameters may not operate depending on the source or adjustments. For details, see each item in "Adjusting the level parameters" (page 27).

²⁾ When these sound fields are selected, there is no sound output from the sub woofer if the front speaker size is set to "LARGE". However, sound will be output from the sub woofer if the digital input signal contains LFE signals.

