

# Wireless Stereo Headphone System

## Operating Instructions

### Checking the included items

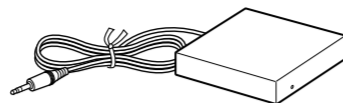

Transmitter TMR-HW300 (1)



Headphones MDR-HW300 (1)

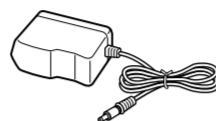

AC adaptor (1)

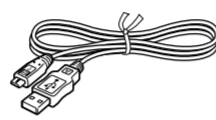

Micro-USB cable (approx. 50 cm (19 3/4 in)) (1)

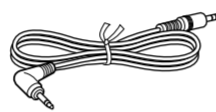

Connecting cable (approx. 1.5 m (59 1/8 in)) (1)

### Features

Thank you for purchasing the Sony MDR-HW300K Wireless Stereo Headphone System. Before operating the unit, please read this manual thoroughly and retain it for future reference.

Some features are:

- **High quality sound with uncompressed digital wireless transmission**  
2.4 GHz digital wireless transmission prevents interference of obstacles. High quality sound with uncompressed digital wireless transmission.
- **Powerful and expressive sound**  
Powerful and expressive sound with 40 mm neodymium driver unit.
- **Comfortable fit even for a long period of time**  
Comfortable fit for long period of time with soft earpads and head cushion.
- **Real-time automatic channel selection prevents sound break up**  
Real-time automatic channel selection on headphone system for best reception of signal. This system can switch to a free channel automatically without any sound interruption before the signal is blocked.
- **Volume control function on headphones**
- **Easy charging with USB port**  
3 hours to fully charge the battery, and approx. 10 hours playback time. Can be used while charging the headphones.
- **Wired design option**  
Also works wired design headphones with supplied connecting cable. You can enjoy content on a smartphone, PC and tablet with this wired option.
- **Swivel design for easy storage**



\* 4 5 3 1 9 2 8 1 1 \* (1)

©2013 Sony Corporation Printed in China

MDR-HW300K

English Wireless Stereo Headphone System

### WARNING

To reduce the risk of fire or electric shock, do not expose this apparatus to rain or moisture.

To reduce the risk of fire or electric shock, do not expose this apparatus to dripping or splashing, and do not place objects filled with liquids, such as vases, on the apparatus.

As the main plug of AC power adaptor is used to disconnect the AC power adaptor from the mains, connect it to an easily accessible AC outlet. Should you notice an abnormality in it, disconnect it from the AC outlet immediately.

Do not expose the batteries (battery pack or batteries installed) to excessive heat such as sunshine, fire or the like for a long time.

To avoid electrical shock, do not open the cabinet. Refer servicing to qualified personnel only.

Do not install the AC power adaptor in a confined space, such as a bookcase or built-in cabinet.

Excessive sound pressure from earphones and headphones can cause hearing loss.

### NOTICE FOR THE CUSTOMERS IN THE U.S.A.

This equipment has been tested and found to comply with the limits for a Class B digital device, pursuant to Part 15 of the FCC Rules. These limits are designed to provide reasonable protection against harmful interference in a residential installation. This equipment generates, uses and can radiate radio frequency energy and, if not installed and used in accordance with the instructions, may cause harmful interference to radio communications. However, there is no guarantee that interference will not occur in a particular installation. If this equipment does cause harmful interference to radio or television reception, which can be determined by turning the equipment off and on, the user is encouraged to try to correct the interference by one or more of the following measures:

- Reorient or relocate the receiving antenna.
- Increase the separation between the equipment and receiver.
- Connect the equipment into an outlet on a circuit different from that to which the receiver is connected.
- Consult the dealer or an experienced radio/TV technician for help.

You are cautioned that any changes or modifications not expressly approved in this manual could void your authority to operate this equipment.

### For the customers in the Canada

This device complies with Industry Canada licence-exempt RSS standard(s). Operation is subject to the following two conditions: (1) this device may not cause interference, and (2) this device must accept any interference, including interference that may cause undesired operation of the device.

### For the customers in the U.S.A. and Canada

This transmitter complies with FCC/IC radiation exposure limits set forth for an uncontrolled environment and meets the FCC radio frequency (RF) Exposure Guidelines and RSS-102 of the IC radio frequency (RF) Exposure rules. This transmitter has very low levels of RF energy that it deemed to comply without maximum permissive exposure evaluation (MPE). But it is desirable that it should be installed and operated keeping the radiator at least 20 cm or more away from person's body (excluding extremities: hands, wrists, feet and ankles).

This Transmitter and Wireless stereo headphones must not be co-located or operated in conjunction with any other antenna or transmitter.

### How to use

#### 1 Charge the headphones.

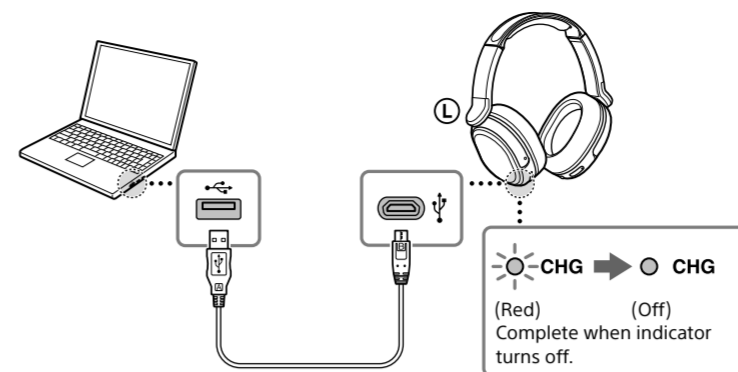

#### 2 Connect the AC adaptor.

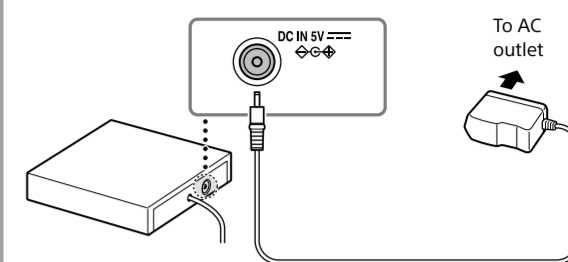

#### 3 Connect the A/V component, following hookup A or B below.

##### A Using the headphone jack of the A/V component

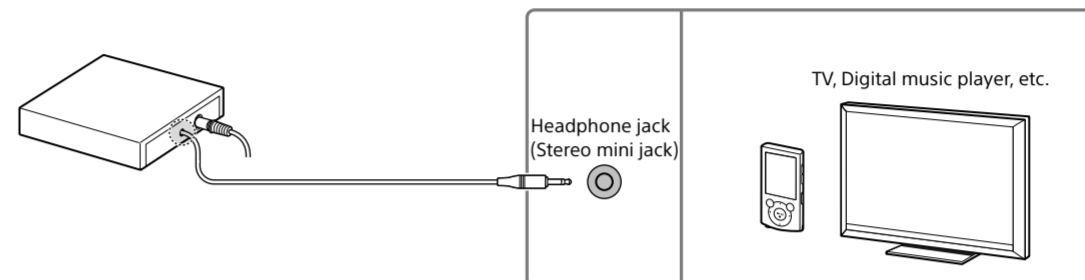

##### B Using the audio out (L/R) jacks of the A/V component

Use a plug adaptor (not supplied) between the transmitter and the A/V component.

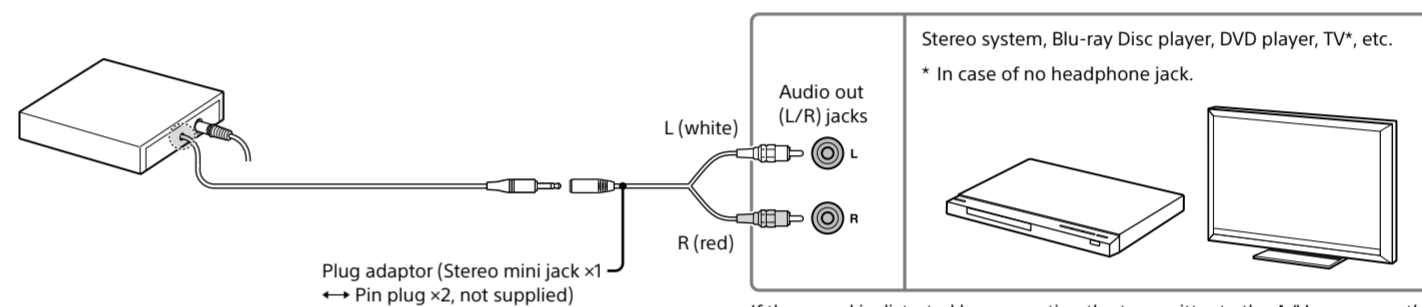

If the sound is distorted by connecting the transmitter to the A/V component's audio out (L/R) jacks, reconnect the transmitter to the headphone jack.

#### 4 Wear the headphones.

##### Before listening

Be sure to lower the volume of the headphones after the I/⏻ (On/Standby) indicator lights up, to reduce the risk of hearing damage.

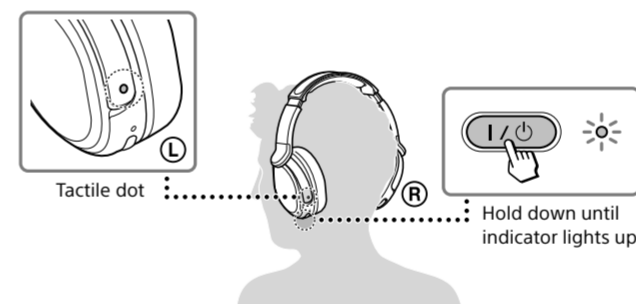

#### 5 Start playback of the A/V component.

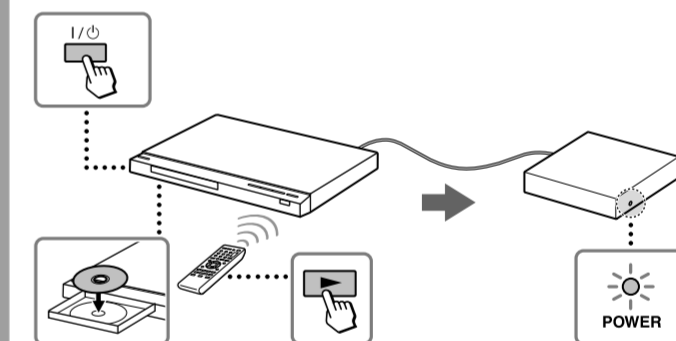

#### 6 Adjust the volume.

The headphones will beep when the volume reaches maximum or minimum.

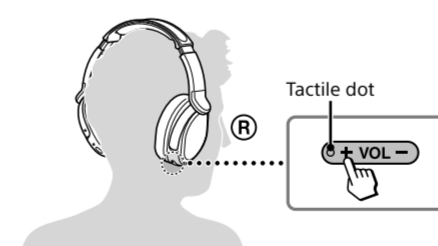

#### After use

1 Stop playback of the A/V component.

2 Hold down the I/⏻ (On/Standby) button of the headphones until the I/⏻ indicator turns off.

##### Tip

The headphones will turn off automatically if RF signal transmission from the transmitter stops for about 5 minutes.

#### If no signal or low signal is input for about 10 minutes

If the transmitter detects no signal, the POWER indicator of the transmitter blinks for about 10 minutes, then the transmitter stops the RF signal transmission automatically\*. The transmitter restarts after receiving an audio signal again.

The transmitter may also stop if the volume of the connected A/V component is too low. In this case, raise the volume of the connected A/V component within the range where the sound is not distorted, then lower the volume of the headphones.

\* If signal noise is output from the connected A/V component, the transmitter may not turn off, even when no audio signal is input.

#### Using the unit by connecting the supplied cable

You can use the unit as ordinary wired headphones by connecting the supplied connecting cable. You can also charge the headphones during wired use. Be sure to use the supplied connecting cable. To reduce the risk of hearing damage, lower the volume of the A/V component before connection.

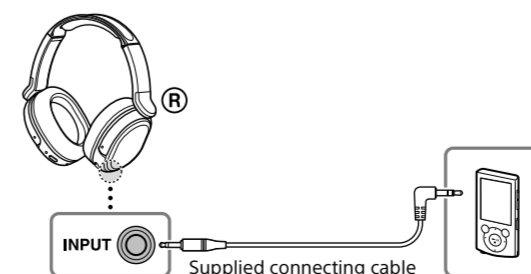

#### Storing the headphones

Check right and left of the headphones before swiveling to store.

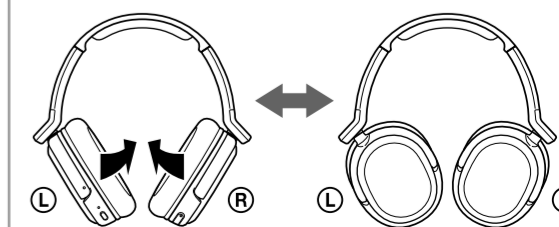

## Product information

### Listening to audio from the headphones and TV speakers simultaneously

Connect the transmitter to your Cable Box/Satellite Box rather than your television. Some TVs can be set to output audio from both its speakers and headphone jack. For details on the setting, refer to the operating instructions of your TV.

### Note on monaural component connection

If you connect the transmitter directly to an earphone jack (monaural mini jack) of an A/V component, the audio signal may not be output through the right channel.

## Charging

## Tips for charging

### Charge the headphones first

The headphones contain a rechargeable Lithium-Ion battery, which should be charged before using for the first time.

### Charging and usage time

Approx. charging time	Approx. usage time <sup>1)</sup>
3 hours <sup>2)</sup>	10 hours <sup>3)</sup>

1) at 1 kHz, 0.1 mW + 0.1 mW output

2) hours required to fully charge an empty battery

3) Time may vary, depending on the temperature or conditions of use.

### Remaining battery

To check the remaining battery charge of the headphones, turn them on, and check the I/🔊 indicator. The battery is still serviceable when the indicator lights up green. Charge the headphones if the I/🔊 indicator turns off, dims, flashes, or the sound becomes distorted or noisy.

### To charge the headphones from an AC outlet

If you recharge the headphones by connecting to an AC outlet, use the USB Charging AC Power Adaptor AC-UD11 (not supplied). For more information, refer to the operating instructions supplied with the adaptor.

### Notes

- Use only the supplied micro-USB cable. Do not use any other USB cable.
- If the headphones are not used for a long time, the CHG indicator may take a while to light after you connect it to the computer. In this case, do not disconnect the micro-USB cable from the headphones and wait until the CHG indicator lights up.
- Charge the headphones in an ambient temperature of between 5 °C to 35 °C (41 °F to 95 °F). If you try to charge the headphones in an ambient temperature outside this range, the CHG indicator may flash and charging will not be completed properly.
- If the computer enters hibernation mode while connected to the headphones, charging will not be completed properly. Check the setting of the computer before charging. The CHG indicator will turn off automatically when the computer enters hibernation. Charge the headphones again in this case.
- Connect the headphones directly to a computer. Charging may not be completed properly by an indirect connection, such as via a USB hub.
- When the battery life reduces to half, this may be the end of battery lifetime. For how to change batteries, consult your place of purchase or a Sony dealer.

## Specifications

## Tips for volume setting

- If you connect the transmitter to the headphone jack of the A/V component, set the volume of the A/V component as high as possible but not so high that the audio signal becomes distorted.
- When watching videos, be careful not to raise the volume too high in quiet scenes. You may hurt your ears when a loud scene is played.

## RF signal transmission

## area

The approximate RF signal transmission area from the transmitter is up to 30 m (100 ft). The sound may be interrupted if the headphones are out of RF signal transmission area, or reception conditions deteriorate.

### Notes

- Because this system transmits signals at 2.4 GHz, sound may be interrupted if interference occurs. This is due to radio frequency characteristics, and is not a malfunction.
- Any noise you hear through the headphones may vary depending on the transmitter position and room conditions. It is recommended that you place the transmitter in a location that produces the clearest sound.
- Sound may be interrupted if the transmitter is used with other wireless apparatus using 2.4 GHz frequency, or a microwave oven.

## Replacing the earpads

The earpads are replaceable. If the earpads become dirty or worn out, replace them as illustrated below. The earpads are not commercially available. You can order replacements from the store where you purchased this system, or at your nearest Sony dealer.

- Remove the old earpad by pulling it out of the groove on the housing.

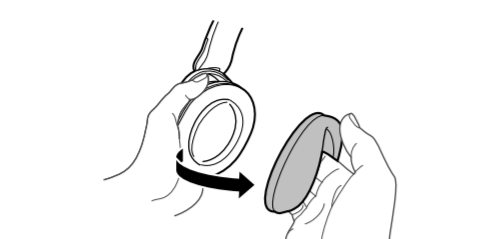

- Fit the new earpad in the groove of the housing. Make sure the earpad is set to the vertical position.



## Accessories

## Troubleshooting

If you run into any problems using this system, use the following checklist. Should any problem persist, consult your nearest Sony dealer.

### No sound/Low sound

- Turn on the headphones.
- Check the connection of the transmitter and A/V component, AC adaptor, and AC outlet.
- Check that the A/V component is turned on.
- If you connect the transmitter to the headphone jack of an A/V component, raise the volume level on the connected A/V component within the range where the sound is not distorted.
- Make sure you are wearing the headphones correctly.
- Charge the headphones. If the I/🔊 indicator is still off after charging, take the headphones to a Sony dealer.
- Raise the headphone volume.

### Distorted or intermittent sound (sometimes with noise)

- Change the position of the transmitter.
- Connect the transmitter to an A/V component using the headphone jack, not the audio out (L/R) jacks.
- If you connect the transmitter to an A/V component using the headphone jack, lower the volume level on the connected A/V component within the range where the sound is not distorted.
- Charge the headphones. If the I/🔊 indicator is still off after charging, take the headphones to a Sony dealer.
- Check if there is any wireless apparatus using 2.4 GHz frequency or a microwave oven in the vicinity.

### Loud background noise

- Check if there is any wireless apparatus using 2.4 GHz frequency, or a microwave oven in the vicinity.
- If you connect the transmitter to the headphone jack of an A/V component, raise the volume level on the connected A/V component within the range where the sound is not distorted.
- Charge the headphones. If the I/🔊 indicator is still off after charging, take the headphones to a Sony dealer.

### The sound cuts off

- The transmitter stops the RF signal transmission automatically if the transmitter detects no signal or the volume of the connected A/V component is too low for about 10 minutes. Raise the volume of the connected A/V component within the range where the sound is not distorted.

### Battery cannot be charged/CHG indicator flashes, or does not light up

- Check that the headphones and the computer are firmly connected by the supplied micro-USB cable.
- Check that the computer is turned on and not in standby, sleep or hibernation mode.
- Check that the headphones and the computer are directly connected, not via a USB hub.
- A problem may occur with the connected USB port of the computer. Connect to another USB port if it is available.
- Try the USB connection procedure again in cases other than those stated above.

### A repeated beep sounds and the headphones cannot receive an audio signal from the transmitter

- Move within the RF signal transmission area.
- Check the connection of the transmitter and A/V component, AC adaptor, and AC outlet.
- Check if there is any wireless apparatus using 2.4 GHz frequency or a microwave oven in the vicinity.
- Change the position of the transmitter.
- The transmitter stops the RF signal transmission automatically if the transmitter detects no signal or the volume of the connected A/V component is too low for about 10 minutes. Play back the connected A/V component, or raise the volume of the A/V component within the range where the sound is not distorted.

## Precautions

### On safety

- Do not drop, hit, or otherwise expose the headphones to strong shock of any kind. This could damage the product.
- Do not disassemble or attempt to open any parts of the system.

### Notes on the AC adaptor

- Insert the AC adaptor plug firmly.
- Be sure to use the supplied AC adaptor. Using AC adaptors with different plug polarity or other characteristics can cause product failure.



- Be sure to always use the supplied AC adaptor. Even AC adaptors having the same voltage and plug polarity can damage this product due to the current capacity or other factors.

### On power sources and placement

- If you are not going to use the system for a long time, unplug the AC adaptor from the AC outlet. When removing the plug, grip the AC adaptor. Do not pull on the cord.
- Do not place the system in any of the following locations.
  - Location exposed to direct sunlight, near a heater, or other extremely high-temperature location
  - Dusty location
  - On an unsteady or inclined surface
  - Location exposed to large amounts of vibration
  - Bathroom or other high-humidity locations

### On headphones

### Act considerably

When the volume is too high, the sound leaks outside the headphones. Be careful not to raise the volume so high that it bothers people around you.

There is a tendency to raise the volume when using in noisy places. However, for reasons of safety, it is advised to keep the volume at a level whereby you can still hear sounds around you.

### On cleaning

Use a soft cloth slightly moistened with mild detergent solution. Do not use solvents such as thinner, benzene or alcohol as these may damage the surface.

### When the product breaks

- When the product breaks, or if a foreign object gets inside the unit, immediately turn off the power and consult your nearest Sony dealer.
- When taking the system to a Sony dealer, be sure to take both the headphones and transmitter.

## Specifications

### Wireless stereo transmitter (TMR-HW300)

Modulation System	GFSK
Carrier wave frequency	2.406 GHz - 2.478 GHz
Transmission distance	Approx. 30 m (100 ft) of longest
Frequency response	20 Hz - 23,000 Hz
Distortion rate	1% or less (1 kHz)
Audio inputs	Stereo mini plug
Power requirements	DC 5 V (from the supplied AC adaptor)
Dimensions	Approx. 75 mm × 18 mm × 75 mm (3 in × ¾ in × 3 in) (w/h/d)
Mass	Approx. 70 g (2.5 oz)
Rated power consumption	0.6 W

### Wireless stereo headphones (MDR-HW300)

Sensitivity	98 dB/mW
Playback frequency range	10 Hz – 22,000 Hz
Impedance	32 Ω at 1 kHz
Power handling capacity	1,000 mW (IEC*)
Power source	Built-in lithium-ion rechargeable battery
Mass	Approx. 190 g (6.7 oz)

\* IEC = International Electrotechnical Commission

### Included items

Wireless stereo transmitter TMR-HW300
Wireless stereo headphones MDR-HW300
AC adaptor (5 V) (1)
Micro-USB cable (approx. 50 cm (19 ¾ in)) (1)
Connecting cable (approx. 1.5 m (59 ⅞ in)) (1)
Operating Instructions (this manual) (1)
Card warranty (1)

### Recommended accessory

To recharge the headphones from an AC outlet: USB Charging AC Power Adaptor AC-UD11

### System requirements for battery charge using USB

Personal Computer with pre-installed with any of the following operating systems and USB port:
Windows 8 / Windows 8 Pro
Windows 7
Starter / Home Premium / Professional / Ultimate
Windows Vista (Service Pack 2 or later)
Home Basic / Home Premium / Business / Ultimate
Windows XP (Service Pack 3 or later)
Home Edition / Professional / Media Center Edition 2004 / Media Center Edition 2005
Mac OS X (version.10.3 or later)

### Trademark Notice

Microsoft, Windows and Windows Vista are registered trademarks or trademarks of Microsoft Corporation in the United States and/or other countries. Macintosh and Mac OS are trademarks of Apple Inc., registered in the U.S. and other countries. All other trademarks and registered trademarks are trademarks or registered trademarks of their respective holders. In this manual, ™ and ® marks are not specified.

Design and specifications are subject to change without notice.