

# Video Cassette Recorder

Model:

**EVO-220**

---

## Operation Manual

(Page 2 to 25)

Before operating the unit, please read this manual thoroughly and retain it for future reference.

## Mode d'emploi

(Page 26 à couverture dos)

Avant la mise en service de l'appareil, prière de lire attentivement ce mode d'emploi que l'on conservera pour toutes références ultérieures.



© 1993 by Sony Corporation

**WARNING**

**To prevent fire or shock hazard, do not expose the unit to rain or moisture.**



This symbol is intended to alert the user to the presence of important operating and maintenance (servicing) instructions in the literature accompanying the appliance.

For detailed safety precautions, see the leaflet "IMPORTANT SAFEGUARDS".

**CAUTION**

You are cautioned that any changes or modifications not expressly approved in this manual could void your authority to operate this equipment.

**NOTE**

This equipment has been tested and found to comply with the limits for a Class B digital device, pursuant to Part 15 of the FCC Rules. These limits are designed to provide reasonable protection against harmful interference in a residential installation. This equipment generates, uses and can radiate frequency energy, and if not installed and used in accordance with the instructions, may cause harmful interference to radio communications. However, there is no guarantee that interference will not occur in a particular installation. If this equipment does cause harmful interference to radio or television reception, which can be determined by turning the equipment off and on, the user is encouraged to try to correct the interference by one or more of the following measures:

- Reorient or relocate the receiving antenna, and receiver.
- Connect the equipment into an outlet on a circuit different from that to which the receiver is connected.
- Consult the dealer or an experienced radio/TV technician for help.

Television programs, films, video tapes and other materials may be copyrighted. Unauthorized recording of such material may be contrary to the provisions of the copyright laws.

**For the customer in Canada**

This apparatus complies with Class B limits for radio noise emissions set out in Radio Interference Regulations.

**Owner's Record**

The model and serial numbers are located on the bottom. Record the serial number in the space provided below. Refer to these numbers whenever you call upon your Sony dealer regarding this product.

Model No. EVO-220

Serial No. \_\_\_\_\_

**Precautions**

- Operate the recorder on 6.0 V (battery pack)/7.5 V (AC power adaptor AC-S10)/6.5 V (DC pack DCP-27).
- Do not operate the recorder where the temperature is below 0°C (32°F) or above 40°C (104°F).
- For DC or AC power supply, use the accessories recommended in this manual.
- Should any solid object or liquid fall into the cabinet, unplug the recorder and have it checked by qualified personnel before operating it any further.
- Avoid rough handling or mechanical shock to the recorder.
- Remove the battery casettes from the recorder after recording or playback, and store them in their cases.
- Do not wrap up the recorder and operate it because damaging heat may build up internally.
- Avoid using and storing the recorder in the following locations:
  - susceptible to vibration
  - exposed to strong magnetic fields
  - near TV or radio transmitters where strong radio waves are generated
  - on the sand

# Table of Contents



Overview of the EVO-220 ..... 5  
Features ..... 5  
Location of Parts and Controls ..... 6



Power Sources ..... 8  
Using a Wall Outlet for Indoor Use ..... 9  
Using a Battery Pack for Outdoor Use ..... 10  
Using the Battery Pack Efficiently ..... 11  
Using a Car Battery ..... 13

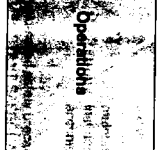

Playing Back a Tape ..... 14  
Connection ..... 14  
Inserting a Cassette ..... 15  
Playing Back a Tape ..... 16  
Using the Tape Counter ..... 18  
Selecting the Monitor Sound ..... 18  
Recording a Tape ..... 20  
Connection ..... 20  
Recording a Tape ..... 20



Maintenance ..... 22  
Main Unit ..... 22  
Video Head Cleaning ..... 22  
Moisture Condensation ..... 23  
Using Your Recorder Abroad ..... 23  
Specifications ..... 24  
Troubleshooting ..... 25

# Preliminary Overview of the EVO-220

The EVO-220 is an 8 mm video cassette recorder. Its compact and lightweight design allows you to play back, record and edit video tapes anywhere and any time you like.

## Features

- AFM Hi-Fi Stereo for high quality sound\*
- Playback of tapes recorded in Hi8 video system\*\*
- (LANC) REMOTE terminal\*\*\*

### • AFM Hi-Fi Stereo System

The AFM Hi-Fi stereo system of this recorder provides a live stereo sound atmosphere. In addition, you can also play back a tape with bilingual program. With this recorder, you can select the sound to be output while playing back a tape both with stereo and bilingual programs. (See page 18.)

In the following cases, sound will be monaural.

- When you play back a tape recorded on an AFM Hi-Fi monaural video recorder, by using this recorder.
- When you play back a tape recorded on this recorder, by using an AFM Hi-Fi monaural video recorder.
- When you use only the AUDIO-L (MONO) jack without using the AUDIO-R jack. (See page 19.)
- When you use the AV OUT (stereo mini) jack. (See page 19.)

PCM (Pulse Code Modulation) recording/playback, that is, digital sound recording/playback, is not possible with this recorder. PCM sound recorded with another recorder cannot be played back with this recorder.

### \*\* Hi8 playback

- Playback of tapes recorded in SP mode of the Hi8 video system is possible on this recorder.
- Recording in the Hi8 video system is not available.
  - Playback of tapes recorded in LP mode of the Hi8 system is not available.
  - The high resolution which a conventional Hi8 VCR gives the picture cannot be obtained.
  - Noise may appear on the screen during playback.

### \*\*\* (LANC) REMOTE terminal

LANC stands for Local Application Control bus system. The LANC terminal is used for controlling the tape transport of video equipment, and peripherals (Remote Commander, Editing Controller, V-Box Computer, Interface, etc.) or other VCRs (equipped with the (LANC) terminal) connected to it. This terminal has the same function as those indicated as CONTROL L or REMOTE.

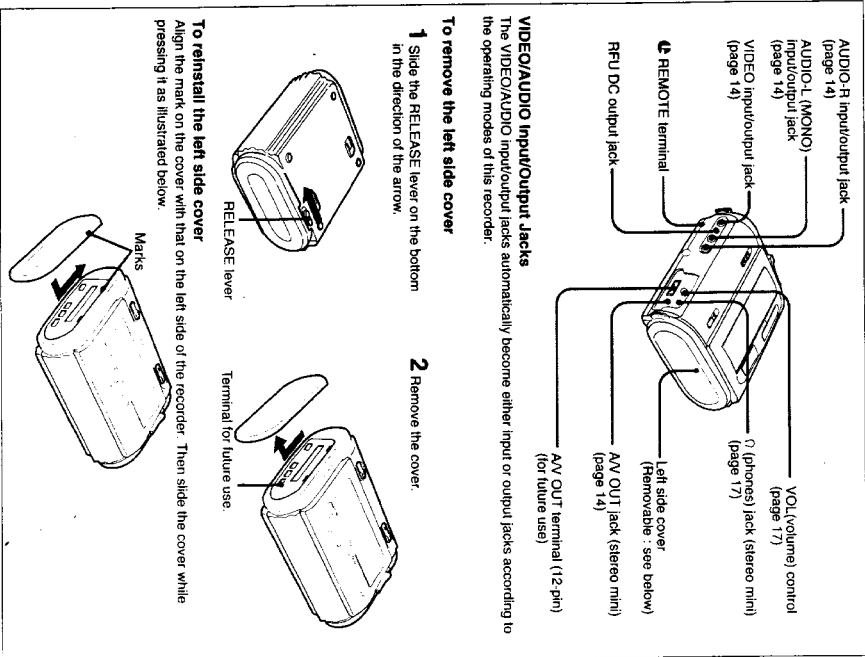
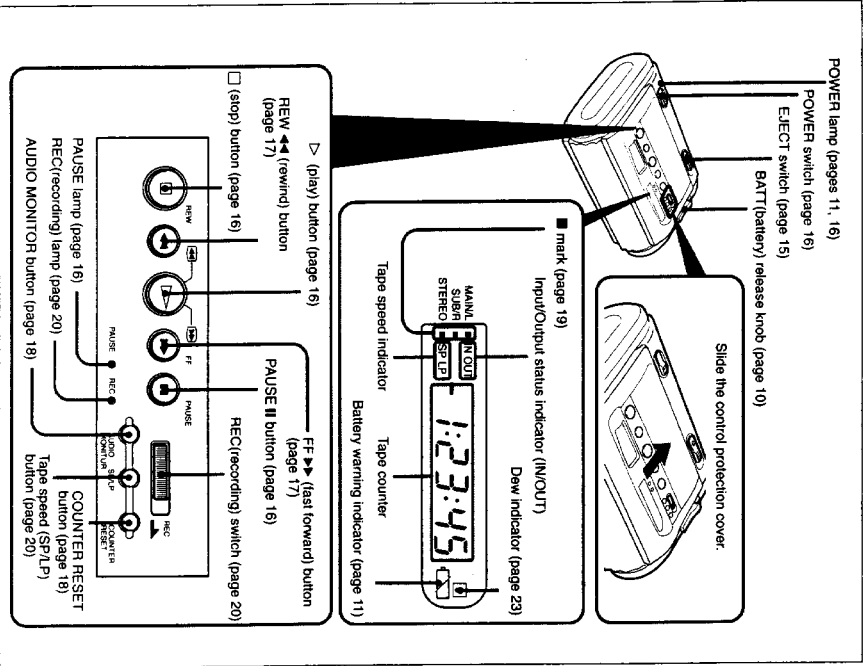

Select and purchase the best power source for your own needs.

Place	Power source	Page
Indoors	AC power adaptor AC-S10 (not supplied)	9
Outdoors	Battery pack NP-80, NP-80D, NP-77HD, NP-77H, NP-69H, NP-60D or NP-55H (not supplied)	10
In a car	DC pack DCP-77 (supplied) or Car battery charger/adaptor DC-S10 (not supplied)	13

DC pack DCP-77 is supplied with this recorder; all other accessories for your special needs are available from your Sony dealer.

Disconnecting the power source during recording or playback operations may damage the inserted cassette tape. If this should happen, supply power again immediately and switch on the power.

**Using a Wall Outlet for Indoor Use**

Use an AC-S10 AC power adaptor (not supplied).

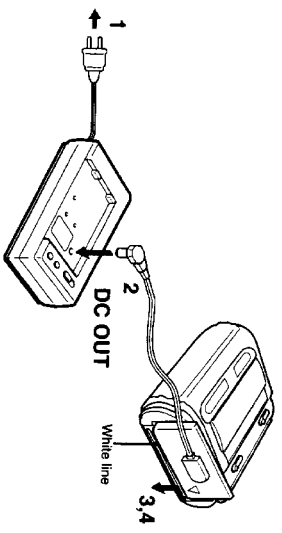

- 1 Plug in the AC power adaptor to a wall outlet. The POWER lamp (green) on the AC-S10 lights up and the power comes on.
- 2 Insert one end of the connecting cord (supplied with the AC-S10) into the DC OUT jack of the AC-S10.
- 3 Align the lower side edge of the connecting plate with the white line printed on the recorder.
- 4 Press the connecting plate and slide it in the direction of the ► mark.

**To remove the connecting plate**

Slide out the connecting plate while sliding the BATT release knob.

**CAUTION**

TO PREVENT ELECTRIC SHOCK, DO NOT USE THIS POLARIZED AC PLUG WITH AN EXTENSION CORD, RECEPTACLE OR OTHER OUTLET UNLESS THE BLADES CAN BE FULLY INSERTED TO PREVENT BLADE EXPOSURE.

- The recorder is not disconnected from the AC power source as long as it is connected to a wall outlet. One blade of the plug is wider than the other for the purpose of safety and will fit into a wall outlet only one way. If you are unable to insert the plug fully into the outlet, contact your dealer.
- While the recorder is in use, particularly during charging, keep it away from AM receivers and video equipment because it will disturb AM reception and video operation.

**Using a Battery Pack for Outdoor Use**

Use a fully-charged battery pack.

**To attach a battery pack to this recorder**

Align the lower side edge of the battery with the white line printed on the recorder, press the battery pack and then slide it in the direction of the arrow.

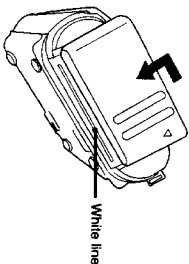

White line

**To remove the battery pack**

Slide out the battery pack while sliding the BATT release knob in the direction of the arrow as illustrated below.

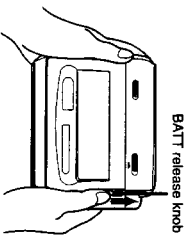

BATT release knob

**When to replace battery packs**

When a battery becomes weak, the POWER lamp and the battery warning indicator (⚡) starts flashing slowly. You need to replace the battery then.

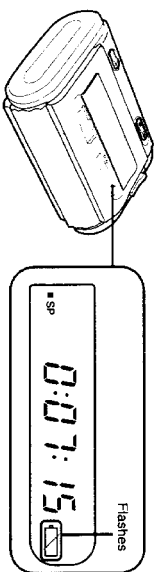

Turn off the power before replacing the battery pack.

Especially during recording, keep the cassette inside the cassette holder while replacing the battery pack. When a fresh battery is attached, recording can be resumed smoothly without any picture distortion.

**A fully-charged battery pack lasts for:**

Battery Pack	NP-90/60D	NP-77H/77HD	NP-66H	NP-60D	NP-55H
Playback	Approx. 240 min	Approx. 210 min	Approx. 155 min	Approx. 120 min	Approx. 105 min
Recording	Approx. 220 min	Approx. 190 min	Approx. 145 min	Approx. 110 min	Approx. 95 min

**Using the Battery Pack Efficiently**

**Preparing battery packs**

Prepare 2 or 3 times more battery power than you plan to use.

The published battery capacity is measured in a continuously playing the recorder at room temperature starting with a fully charged battery. Fast winding or rewinding uses much more power than normal playing. Consequently, battery consumption becomes faster when these operations are performed frequently.

**Battery consumption is faster in a cold climate**

Cold climates reduce the efficiency of a battery and cause it to run out more quickly.

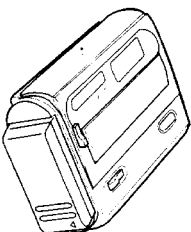

**Notes on charging**

Before using a battery pack, charge it fully. A newly purchased battery pack also needs to be charged before its first use.



**Recharge a battery pack only when it is fully used out**

Avoid recharging only partly used battery packs. Repeated charging of partly discharged battery packs reduces their capacity and shortens their overall life span. The original capacity can sometimes be recovered by fully discharging and then fully recharging the battery pack.

**Rechargeable battery packs**

**Battery pack care**

- Remove the battery pack from the recorder after use, and keep it in a cool place. When the battery pack is installed on the recorder, a small amount of current flows to the recorder even if the power is switched off. This causes overdischarge and so shortens battery life.
- The battery pack is always discharging a little even when not in use. Thus, the battery should be charged if you do not use it for an extended period of time. (Again remember discharge it fully before charging it.)
- If the terminals (metal parts on the back) are dirty, the battery capacity will be reduced. When the terminals are dirty, or when the battery pack has not been used for a long time, attach and remove it several times. This will improve the contact between the battery pack and the recorder. Also, wipe the + and - terminals with a soft cloth or paper.
- If the battery pack is not used for a long time (about 1 year) and you charge it again, the battery capacity will be reduced. After several charging and discharging cycles, the battery will recover its original capacity.

**How to use the switch on the battery pack**

Use this switch as a reminder of the battery's condition. For example, set the switch to the no-marked position when charging is completed. Set the switch to the red-marked position when the battery is discharged.



Switch

**Battery life**

A battery can be fully charged and discharged about 500 times under normal temperatures. If the battery warning indicator (⚡) flashes just after turning on the recorder, even though a fully charged battery pack has been installed, its battery life is almost over. Replace the battery pack with a new one.

**Best temperature for charging**

A lower temperature requires a longer charging time. Charging in a temperature ranging from 10°C to 30°C (50°F to 86°F) is recommended.

**Why a battery pack heats up**

While a battery pack is being charged or used, the chemical change occurring inside the battery pack releases heat. The battery pack becomes warm, but this is normal and not dangerous.

**Warning**

If the + and - terminals are short-circuited with a piece of metal, the battery heats up abnormally. This is very dangerous. Never put an uncovered battery pack in a pocket together with a key holder or other metals.

**Be sure to observe the following**

- To prevent an accident caused by a short circuit, do not allow metal objects, such as a necklace or key holder, to touch the battery terminals. Carry the battery pack in its case or with the terminal cover attached to it.
- Keep the battery pack away from fire.
- Keep the battery pack dry.
- Do not open or convert the battery pack.
- Do not expose the battery pack to any mechanical shock.

**Using a Car Battery**

Use the supplied DCP-77 DC pack.

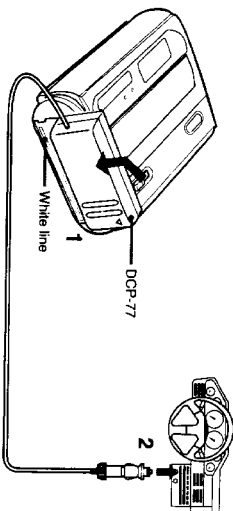

**1** Attach the DC pack to the recorder by aligning the lower side edge of the DC pack with the white line on the recorder, press the DC pack and then slide it in the direction of the mark.

**2** Plug the power cord into the cigarette lighter socket.

- Only connect the DCP-77 to a car with a negative ground 12 V or 24 V battery.
- The DCP-55 is not recommended for this recorder because its power is not enough to operate this recorder.

**Cautions on using this recorder in a car**

- For your safety, do not play back video tapes or operate the controls while driving.
- Avoid leaving the recorder in a place with very high temperatures. If you do, it may cause distortion of the cabinet or malfunction of the recorder.
- If you use this recorder while the car engine is stopped, the car battery will be discharged. Avoid running this recorder from the car battery more than 12 hours without recharging it.
- Remove the power cord from the cigarette lighter socket if you do not use the recorder for a long time.

**Connection**

① To connect a liquid crystal TV

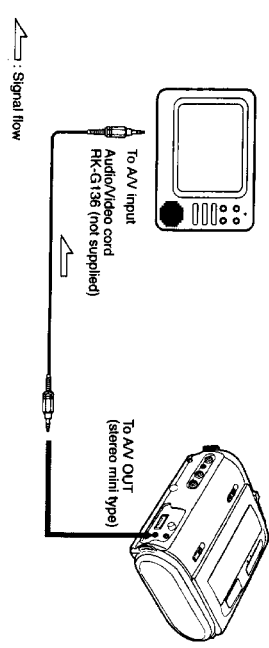

② To connect a TV or monitor with audio/video inputs

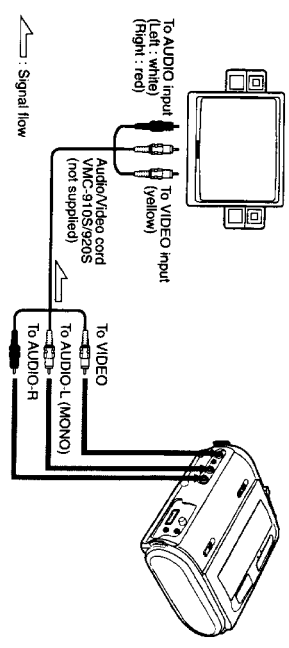

**If your TV or monitor is monaural**  
 Use only the yellow (VIDEO) and the white (AUDIO-L (MONO)) jack on this recorder. Left and right channel sounds are mixed and output from the white (AUDIO-L (MONO)) jack. Leave the red (AUDIO-R) jack unplugged. You can use the VMC-710M/720M monaural-audio/video cord rather than the VMC-910S/920S stereo-audio/video cord used above. In this case, connect the yellow plug to the yellow jack and the black plug to the white jack on this recorder.

**Inserting a Cassette**

Make sure that the power source is attached to this recorder.

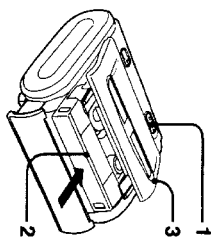

**1 Slide the EJECT switch in the direction of the arrow while pressing the blue button on the switch.**  
 The cassette holder opens automatically. Do not open the cassette holder by force.



**2 Insert a cassette with the window side facing up.**

**3 Press the PUSH mark.**  
 The cassette holder closes automatically.

**To eject a cassette**  
 Slide the EJECT switch in the direction of the arrow while pressing the blue button on the switch. The cassette holder opens automatically and the cassette ejects from the holder.

When you slide the EJECT switch either to insert a cassette or to eject a cassette, the power comes on and the cassette holder opens without the power switched on. After the cassette holder opens, the power goes off automatically. Turn on the power (see page 16) if you want to continue the operation.

**Cassette care**

- Store cassettes in their cases when they are not in use and keep them in an upright position to keep out dust and prevent uneven winding.
- Never insert a cassette upside down into the cassette holder.
- Never cover the small holes on the rear of a cassette or insert anything into the holes.
- Remove a cassette from the recorder when it is not in use.



**Playing Back a Tape**

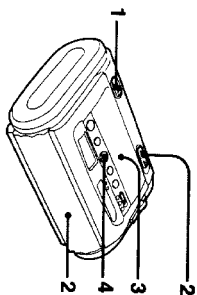

**1** Slide the **POWER** switch in the direction of the arrow.  
The **POWER** lamp lights up.



**2** Insert a recorded tape as explained on page 15.



**3** Slide the control protection cover.

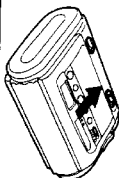

**4** Press **▷** (play).  
Playback starts.



**To stop playback**  
Press  (stop).

**To stop playback for a moment (still picture)**

Press **PAUSE II** so that the **PAUSE** lamp lights up.  
Press **PAUSE II** again or **▷** (play) to resume playback.  
If you leave the recorder in pause (still picture) mode, the recorder stops after approximately 5 minutes.

**To rewind the tape**

Press  (stop) and then press **REW ◀◀** (Rewind mode).  
When you press and hold **REW ◀◀** during playback, you can rewind a tape while viewing pictures.  
(Picture search)  
When you release the button, playback resumes.

**To fast-forward the tape**

Press  (stop) and then press **FF ▶▶** (Fast forward mode).  
When you press and hold **FF ▶▶** during playback, you can fast-forward a tape while viewing pictures.  
(Picture search)  
When you release the button, playback resumes.

**To view pictures while rewinding or fast-forwarding a tape**

Press and hold **REW ◀◀** or **FF ▶▶** to view pictures during rewinding or fast-forwarding a tape.  
When you release the button, rewinding or fast-forwarding resumes.

**To rewind the tape and play it back automatically — Auto play**

Press **▷** (play) while pressing **REW ◀◀**.

**To turn off the power to this recorder**

Slide the **POWER** switch again so that the **POWER** lamp goes off.

**For private listening in stereo**

Connect stereo headphones to the  $\phi$  (phones) jack. You can adjust the output level with the **VOL** (volume) control.

**Caution**

Before connecting headphones, make sure that the **VOL** (volume) control is set to **MIN**; otherwise, it may damage the headphones and your hearing.

**When the playback picture is viewed on a TV or monitor**

The pictures may possibly become black and white or shake vertically in picture search and **FR** picture search modes. Moreover, noise appears during still pictures.

**H18 playback**

Playback of tapes recorded in **SP** mode of the **H18** video system is possible on this recorder. See page 5 for more details.

**Using the Tape Counter**

The counter indicates the tape transport in hours, minutes and seconds. During playback or recording, it shows you the playback or recording time. By noting the counter readings, you can find these points later by referring to the counter. Use the label on the cassette to list the programs and their readings.

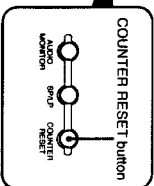
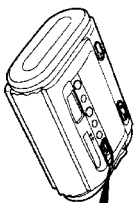

**To reset the counter to "0:00:00"**

Press COUNTER RESET.  
The counter is reset to "0:00:00."

**Notes**

- When you play back a blank tape, the tape counter does not function.
- The counter reading and the point on the tape may not correspond exactly. Use the counter as a guide.
- The difference between the counter reading and the point on the tape may increase by several seconds in the following cases:
  - after repeated fast-forward and rewind
  - when playing back a tape recorded both in SP and LP modes
  - when playing back a tape having a blank portion between recorded portions

**Selecting the Monitor Sound**

You can select the sound to be output when you play back a tape with stereo or bilingual programs. Press **AUDIO MONITOR**.

Each time you press the button, the ■ mark on the display window changes its position, which tells you the sound selected. Select the sound mode by referring to the tables on page 19 according to the sound you want to listen to or record onto other tapes.

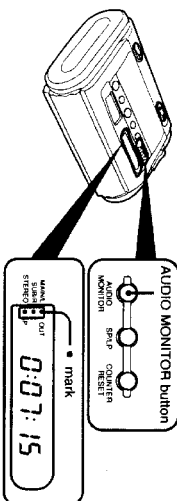

**Sound you can listen to through the headphones**

	■ mark position	Sound through headphones
Stereo tape	MAIN STEREO	Stereo (left and right channels)
	SPD STEREO	Left channel
Bilingual tape	MAIN STEREO	Right channel
	SPD STEREO	Main
Bilingual tape	MAIN MONO	Sub
	SPD MONO	Main and sub

**Note**

When you play back a tape recorded in monaural, the ■ mark does not appear on the display window and the AUDIO MONITOR button does not function.

**Sound output through the audio jacks**

	■ mark position	Sound to be output from		
		AUDIO-L (MONO) jack	AUDIO-R jack	AV/OUT jack (stereo mini type monaural)
Stereo tape	MAIN STEREO	Left channel (Left+right/mixed)	Right channel	Left + right (mixed)
	SPD STEREO	Left channel	Left channel	Left channel
Bilingual tape	MAIN STEREO	Right channel	Right channel	Right channel
	SPD STEREO	Main	Main	Main
Bilingual tape	MAIN MONO	Sub	Sub	Sub
	SPD MONO	Main (Main+sub mixed)	Sub	Main + sub (mixed)

When only the AUDIO-L (MONO) jack is used without using the AUDIO-R jack, the sound becomes monaural. (The sound from the AUDIO-L (MONO) jack is not affected by the AV/OUT jack connection.)

## Connection

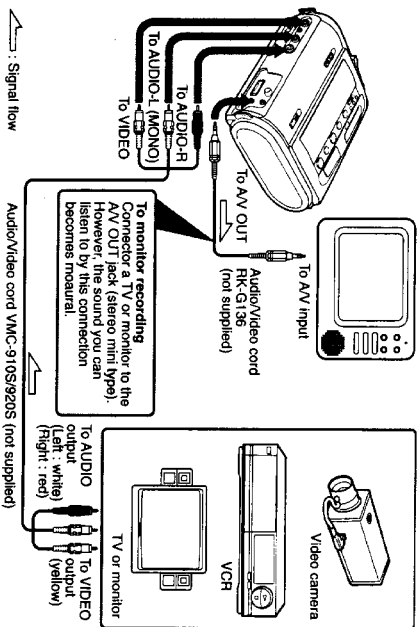

- Notes on connection**
- Note that cord plugs and jacks are color coded. Red plugs and jacks are for the right audio channel, while ones are for the left audio channel and yellow ones are for video signals.
  - If the audio output of other equipment is monaural (Vp), see page 14 for connection.

## Recording a Tape

- 1 Turn on the power to the recorder.
- 2 Insert a cassette.
- 3 Press **SP/LP** on this recorder to select the tape speed.  
See "Recording/playback time" on page 21.

- 4 Slide the **REC** switch in the direction of the arrow.  
This recorder is now put in recording mode.

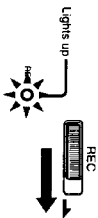

**If other equipment has an EDT function**  
Although this recorder does not have an EDT function, using this function on the equipment connected to this recorder for editing will avoid deterioration of the picture on the duplicated tape.

**When recording from the beginning of the tape**  
Advance the tape for about 15 seconds before recording. This will prevent missing the starting point of the tape played back on the other equipment in the recording.

**When the tape is recorded to the end**  
The tape stops automatically, but the recorder is not turned off. If you are not going to continue operation, turn off the power by sliding the **POWER** switch in the direction of the arrow.

**About recorded sound**  
Recording level is always controlled automatically.

**If power supply is interrupted while recording**  
Recording stops.

**Recording/playback time**  
Two tape speeds (SP/LP) can be selected for recording. The recording time in LP mode is twice as long as that in SP mode. For better picture and sound, recording in SP mode is recommended. During playback, the mode in which the tape has been recorded is selected automatically.

### Difference in color systems

There are different formats for the TV color broadcast system: NTSC, PAL, and SECAM. Video cassette tapes are made to correspond to one of these formats. Use NTSC format cassette tapes for this recorder. You will find "P" on the package of NTSC cassettes.

### To prevent accidental erasure

Slide out the tab on the back of the cassette so that red color is visible.

To re-record on the cassette, slide the tab back.

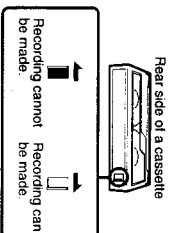

**Note**  
If you record, using this recorder, on a tape that has been recorded with PCM sound, and then if you play back this tape on a VCR with PCM function, the sound may be cut off occasionally. If this happens, set the audio monitor switch of the VCR to the standard position.

### Main Unit

- When the recorder is not used for a long period of time, periodically turn on the power and play back a tape for about three minutes.
- Clean the cabinet with a dry, soft cloth, or a soft cloth lightly moistened with a mild detergent solution. Do not use any type of solvent which may damage the finish.

### Video Head Cleaning

To ensure a clear picture, clean the video heads periodically. If pictures played back are noisy or hardly visible, the video heads may be contaminated. If this happens, clean the video heads with the Sony V8-25CLH cleaning cassette (not supplied) referring to the instructions supplied with it.

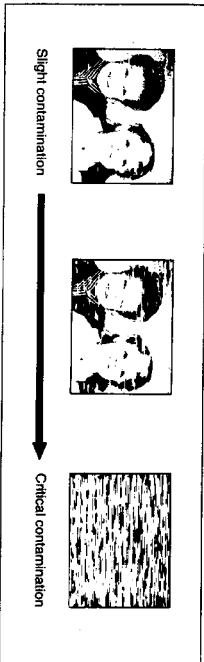

**Caution**  
Do not use commercially available wet-type cleaning cassettes. They may damage the video heads.

**Note**  
If the V8-25CLH cleaning cassette is not available in your area, consult your Sony service facility.

### Video Head Replacement

When playback pictures are not clear even after using the cleaning cassette, the video heads may be damaged. If this happens, the video heads need to be replaced. Consult your Sony service facility for replacing the video heads.

### Moisture Condensation

If this recorder is brought directly from a cold place to a warm place, moisture may condense inside the recorder or on the surface of the tape. If this happens, the tape may stick to the head drum, damaging both the tape and the recorder. Although this recorder is furnished with a moisture sensor to prevent possible damage from condensation, it cannot prevent damage if a tape is left inside the recorder. It is best to remove the tape while you are not using the recorder.

### If moisture condenses inside the recorder

The dew indicator (D) flashes in the display. No button will function except the EJECT switch. Eject the cassette, turn off the recorder and leave the cassette holder open for at least an hour. The recorder can be used again if the dew indicator (D) does not appear when you turn on the recorder.

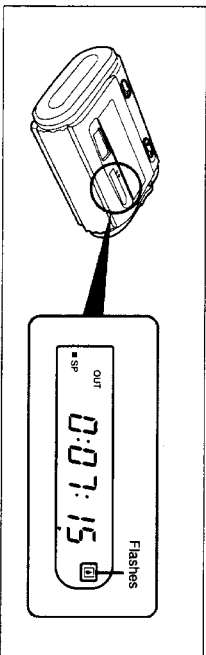

### Using Your Recorder Abroad

If you prepare fully charged battery packs and an AC power adaptor AC-S10 (which can be used in all areas with a local power supply ranging from 100 V - 240 V), you can use your recorder in any country. However, since the shape of the outlet differs widely from country to country, you may need an AC plug adaptor.

Each country has a special TV color broadcast system. This recorder is designed to play back and record using the NTSC color video signals. Playback and recording of video sources of other color signals (PAL and SECAM) cannot be guaranteed.

### Countries using NTSC color signal

Canada, Central America, Japan, Korea, Mexico, Taiwan, the Bahamas, the Philippines, U.S.A., etc.

## System

Video recording system  
Audio recording system

Video signal

Usable cassettes

Tape speed

Recording time

Playback time

Fast forward/rewinding time

## Input/outputs

VIDEO/AUDIO input/output

Video output

Audio input

Audio output

0 (phones)

AV OUT

AV OUT

⚡ REMOTE

## General

Power requirements

Power consumption

Operating temperature

Storage temperature

Dimensions

Mass

Accessories supplied

Design and specifications are subject to change without notice.

If you have a problem with this recorder, first check the power supply source, then go through the list below before calling the Sony service facility. Should the problem persist, consult your Sony service facility.

Symptom	Possible causes and/or corrections
<p>The recorder does not work even though the power is switched on.</p> <p>Power turns off automatically during operation.</p>	<ul style="list-style-type: none"> <li>• The battery pack is not attached.</li> <li>• The battery pack is discharged. Charge it.</li> <li>• AC power adaptor or car battery cord is disconnected.</li> <li>• The battery pack is discharged.</li> </ul>
	<ul style="list-style-type: none"> <li>• The temperature is too low.</li> <li>• The battery pack is worn out.</li> <li>• The battery pack has not been charged fully.</li> </ul>
<p>The playback picture is not clear.</p>	<ul style="list-style-type: none"> <li>• The video heads may be contaminated. Clean the heads using the Sony V8-25CLH cleaning cassette (not supplied).</li> <li>• The video heads may be damaged. Have the video heads replaced with new ones.</li> </ul>
<p>Recording cannot be made.</p>	<ul style="list-style-type: none"> <li>• The safety tab on the cassette is slid out to expose the red mark.</li> <li>• Moisture condensation has occurred.</li> <li>• The tape is at its end.</li> <li>• A cassette is not inserted.</li> </ul>
<p>The cassette cannot be ejected.</p>	<ul style="list-style-type: none"> <li>• Moisture condensation has occurred.</li> <li>• No power is supplied to the recorder.</li> <li>• The battery pack is discharged. Use a fully charged battery.</li> </ul>

# Troubleshooting